

JFLO[®]

拖链 -H 系列

SERIES OF H CHAIN

- ◎ 卡扣式连接方式, 结构紧密牢固。
- ◎ Connection snap-tight structure.

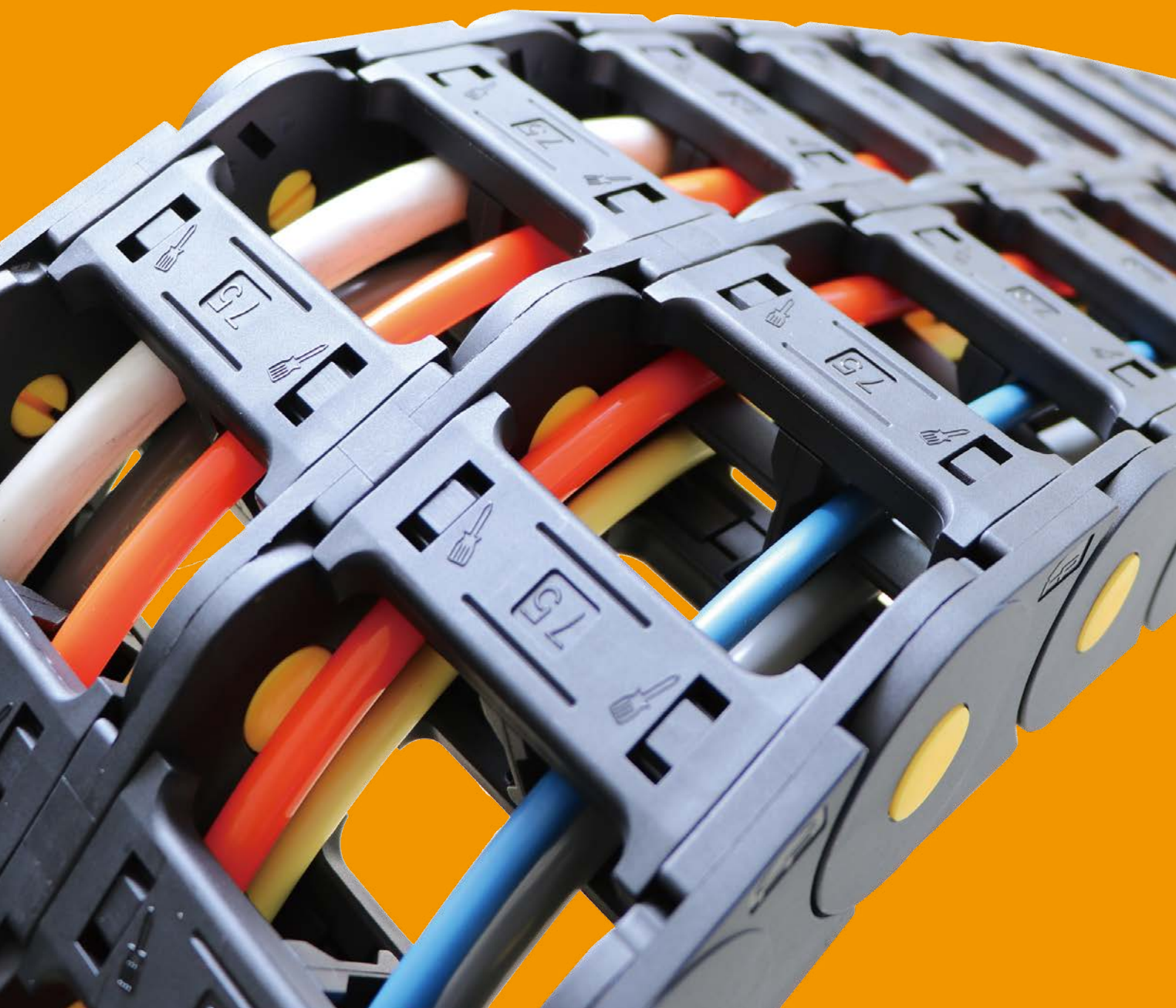

H 系列拖链 H Series

- 01 H20Q.1.S 系列 - 桥式两侧可打开
Series of H20Q.1.S-Bridge type open of both side
- 02 H20F.1.S 系列 - 封闭两侧可打开
Series of H20F.1.S-Sealing open both side
- 03 H25Q.1.S 系列 - 桥式两侧可打开
Series of H25Q.1.S-Bridge type open of both side
- 04 H25F.1.S 系列 - 封闭两侧可打开
Series of H25F.1.S-Sealing open both side
- 05 H30Q.1.S 系列 - 桥式两侧可打开
Series of H30Q.1.S-Bridge type open of both side
- 06 H30F.1.S 系列 - 封闭两侧可打开
Series of H30F.1.S-Sealing open both side
- 07 H35Q.1.S 系列 - 桥式两侧可打开
Series of H35Q.1.S-Bridge type open of both side
- 08 H35F.1.S 系列 - 封闭两侧可打开
Series of H35F.1.S-Sealing open both side
- 09 H45Q.1.S 系列 - 桥式两侧可打开
Series of H45Q.1.S-Bridge type open of both side
- 10 H45F.1.S 系列 - 封闭两侧可打开
Series of H45F.1.S-Sealing open both side
- 11 H55Q.1.S 系列 - 桥式两侧可打开
Series of H55Q.1.S-Bridge type open of both side
- 12 H55F.1.S 系列 - 封闭两侧可打开
Series of H55F.1.S-Sealing open both side
- 13 H65Q.1.S 系列 - 桥式两侧可打开
Series of H65Q.1.S-Bridge type open of both side
- 14 H65F.1.S 系列 - 封闭两侧可打开
Series of H65F.1.S-Sealing open both side
- 15 H80Q.1.S 系列 - 桥式两侧可打开
Series of H80Q.1.S-Bridge type open of both side
- 16 H80F.1.S 系列 - 封闭两侧可打开
Series of H80F.1.S-Sealing open both side

H 系列拖链:

- ◎ 卡扣式链接方式，结构紧密牢固；
- ◎ 所有产品有多种弯曲半径可供选择，以及宽度的选择，快速更换等特性；
- ◎ 所有产品都可以按照客户实际应用的要求组装成半封闭式；
- ◎ 适用于各种运动及行程；
- ◎ 在极高负载及恶劣环境中下使用寿命长久；
- ◎ 在各种环境及气候条件下保证顺畅运行；
- ◎ 耐化学侵蚀；
- ◎ 耐磨损无粘性外护套。

Series of H Chain:

- ◎ Snap-in connection, the structure is tight;
- ◎ All products have a variety of bend radius to choose from, and the choice of the width, quick-change features such as;
- ◎ All products can be assembled in accordance with the requirements of actual customer applications into the semi-closed form;
- ◎ Suitable for all kinds of sports and stroke;
- ◎ Longevity under extremely high load and a variety of environmental and climatic conditions;
- ◎ Wear-resistant sticky outer sheath.

拓展系列 Series of Expand

- 17 HT35Q/F.1.S 系列 - 两侧可打开
Series of HT35Q/F.1.S-open of both side
- 18 HT45Q/F.1.S 系列 - 两侧可打开
Series of HT45Q/F.1.S-open of both side
- 19 HT80Q/F.1.S 系列 - 两侧可打开
Series of HT80Q/F.1.S-open of both side

附录 Appendix

- 20 附录 1- 内部分隔配件
Appendix 1-Inner separating part
- 21 附录 2
Appendix 2
- 22 附录 3
Appendix 3

扣系列有多种颜色可供选择



H20Q.1.S 系列 - 桥式两侧可打开

Series of H20Q.1.S-Bridge type open of both side

JFLO[®]

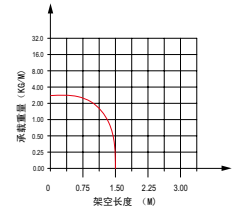
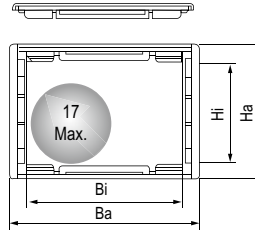

◎ 适用于直径 17 毫米以下线缆 Suitable for 17mm or less of cable.

主要技术参数 Basic technical data

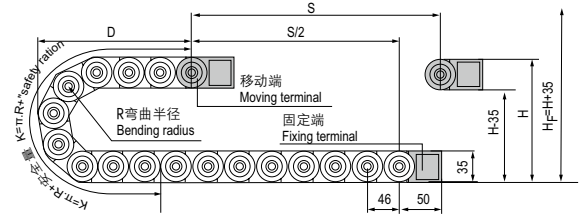

节距 = 46mm, 每米节数 = 22, 链长 = S/2 + K, S = 行程距离, K = π · R + "安全量" + 1 节距
Pitch = 46mm, link per meter = 22, length of chain = S/2 + K, S = stroke, K = π · R + "safety ration" + 1 Pitch

R	55	75	100	125	150
H	145	185	235	285	335
D	119	139	164	189	214
K	276	368	414	506	598

示意图 Drawing

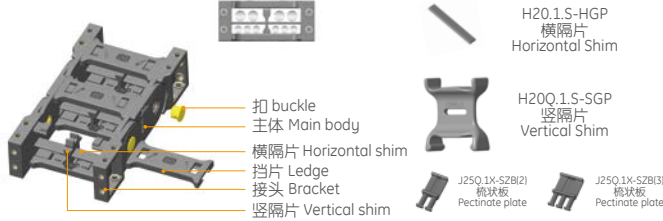

系列号 Series No.	内高 Hi	内宽 Bi	外高 Ha	外宽 Ba	款式 Styles	弯曲半径 Bending radius R	固定接头类型及参数 Bracket type and parameters						代号 No.		
							可配接头类型 Applicable bracket type	孔径 Bore diameter Φ1	孔距 (mm)hole distance						
									A	B	C	D		E	F
H20Q.1.38S	20	38	35	57	Q.S	55,75,100 125,150	F-Q	4.3	15	51	50	15	8.5	61	H20Q.1.38S-FJT
H20Q.1.50S	20	50	35	69	Q.S		F-Q	4.3	15	63	50	15	8.5	73	H20Q.1.50S-FJT
H20Q.1.57S	20	57	35	76	Q.S		F-Q	4.3	15	70	50	15	8.5	80	H20Q.1.57S-FJT
H20Q.1.60S	20	60	35	79	Q.S		F-Q	4.3	15	73	50	15	8.5	83	H20Q.1.60S-FJT
H20Q.1.75S	20	75	35	94	Q.S		F-Q	4.3	15	88	50	15	8.5	98	H20Q.1.75S-FJT
H20Q.1.77S	20	77	35	96	Q.S		F-Q	4.3	15	90	50	15	8.5	100	H20Q.1.77S-FJT
H20Q.1.100S	20	100	35	119	Q.S		F-Q	4.3	15	113	50	15	8.5	123	H20Q.1.100S-FJT
H20Q.1.103S	20	103	35	122	Q.S		F-Q	4.3	15	116	50	15	8.5	126	H20Q.1.103S-FJT
H20Q.1.125S	20	125	35	144	Q.S		F-Q	4.3	15	138	50	15	8.5	148	H20Q.1.125S-FJT

单位 (unit): mm

注: S 表示两侧可打开 Note: S indicates that the both side open

固定接头类型及参数 Fix bracket type and parameters (见表格 See table)



订货示例 Order Example

示例 拖链内高 20、内宽 38、半径 55、长度 1 米 / 22 节 (Sample: inner height 10, inner width 38, radius 55, length 22 links/1 meter)

拖链 Chain H20Q.1.38S R55 1000mm / 22 Links

接头 Bracket H20Q.1.38S-FJT 1 副 (Set)

配件 Accessories 每节装 1 个竖隔片 / 1 个横隔片 (1 vertical shim/1 horizontal shim can be mounted in every link)

注: 可根据客户要求定制各种规格。 Note: Various sizes can be customized according to customer requirements.

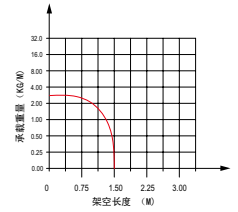
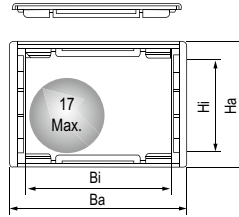
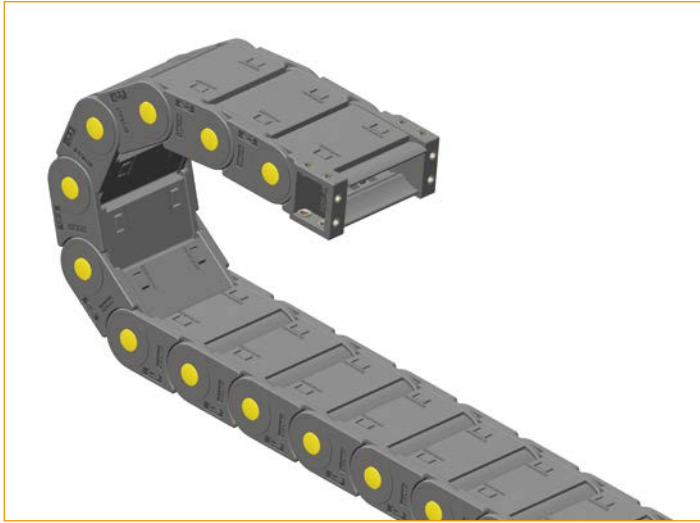

◎ 适用于直径 17 毫米以下线缆 Suitable for 17mm or less of cable.

主要技术参数 Basic technical data

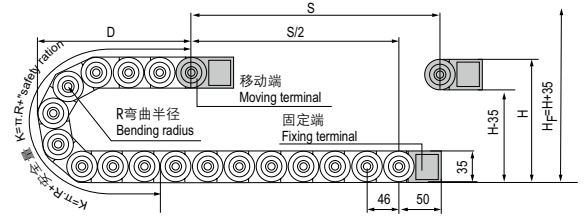

节距=46mm, 每米节数=22, 链长=S/2+K, S=行程距离, K=π·R+"安全量"+1 节距
Pitch=46mm, link per meter=22, length of chain=S/2+K, S=stroke, K=π·R+"safety ration"+1 Pitch

R	75	100	125	150
H	185	235	250	335
D	139	164	171	214
K	368	414	506	598

示意图 Drawing

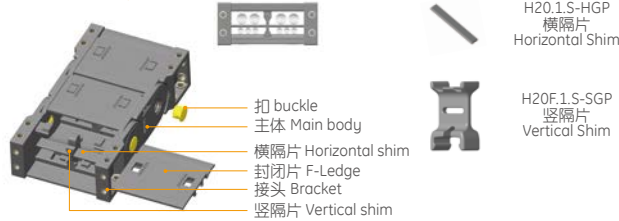

系列号 Series No.	内高 Hi	内宽 Bi	外高 Ha	外宽 Ba	款式 Styles	弯曲半径 Bending radius R	固定接头类型及参数 Bracket type and parameters						代号 No.		
							可配接头类型 Applicable bracket type	孔径 Bore diameter Φ1	孔距 (mm)hole distance						
H20F.1.38S	20	38	35	57	F.S	75,100 125,150	F-F	4.3	15	51	50	15	8.5	61	H20F.1.38S-FJT
H20F.1.50S	20	50	35	69	F.S		F-F	4.3	15	63	50	15	8.5	73	H20F.1.50S-FJT
H20F.1.57S	20	57	35	77	F.S		F-F	4.3	15	70	50	15	8.5	80	H20F.1.57S-FJT
H20F.1.60S	20	60	35	79	F.S		F-F	4.3	15	73	50	15	8.5	83	H20F.1.60S-FJT
H20F.1.75S	20	75	35	94	F.S		F-F	4.3	15	88	50	15	8.5	98	H20F.1.75S-FJT
H20F.1.77S	20	77	35	96	F.S		F-F	4.3	15	90	50	15	8.5	100	H20F.1.77S-FJT
H20F.1.100S	20	100	35	119	F.S		F-F	4.3	15	113	50	15	8.5	123	H20F.1.100S-FJT

单位 (unit): mm

注: S 表示两侧可打开 Note: S indicates that the both side open

固定接头类型及参数 Fix bracket type and parameters (见表格 See table)

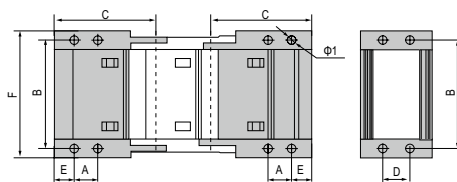

F-F 型接头 F-F type bracket

订货示例 Order Example

示例 拖链内高 20、内宽 50、半径 75、长度 1 米 /22 节 (Sample: inner height 20, inner width 50, radius 75, length 1 meter /22 links)

拖链 Chain H20F.1.50S R75 1000mm /22 Links

接头 Bracket H20F.1.50S-FJT 1 副 (Set)

配件 Accessories 每节装 1 个竖隔片 /1 个横隔片 (1 vertical shim/1 horizontal shim can be mounted in every link)

注: 可根据客户要求定制各种规格。 Note: Various sizes can be customized according to customer requirements.

H25Q.1.S 系列 - 桥式两侧可打开

Series of H25Q.1.S-Bridge type open of both side

JFLO[®]

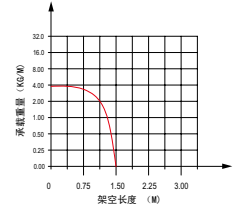
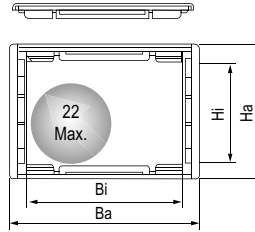
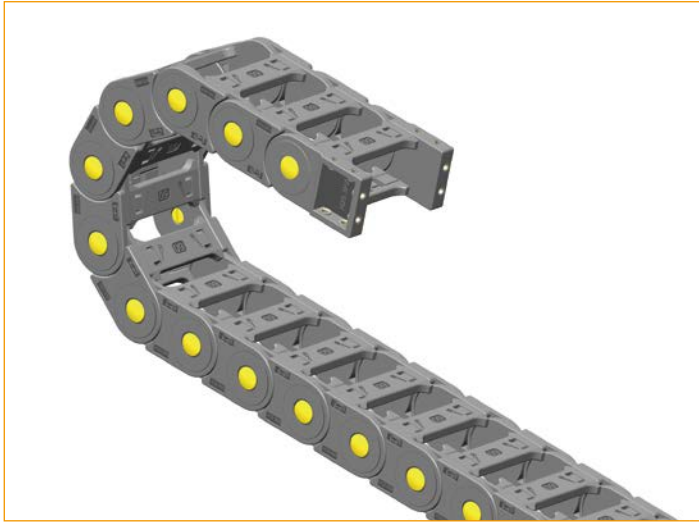

◎ 适用于直径 22 毫米以下线缆 Suitable for 22mm or less of cable.

主要技术参数 Basic technical data

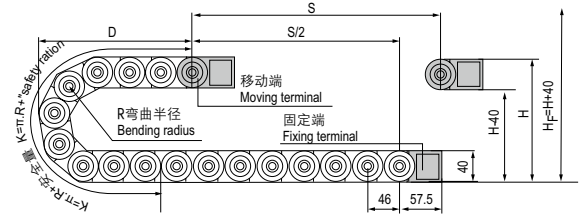

节距=46mm, 每米节数=22, 链长=S/2+K, S=行程距离, K= $\pi \cdot R$ + "安全量"+1 节距
Pitch=46mm, link per meter=22, length of chain=S/2+K, S=stroke. K= $\pi \cdot R$ + "safety ration"+1 Pitch

R	55	75	100	125	150
H	150	190	240	290	340
D	121	141	166	191	216
K	276	368	414	506	598

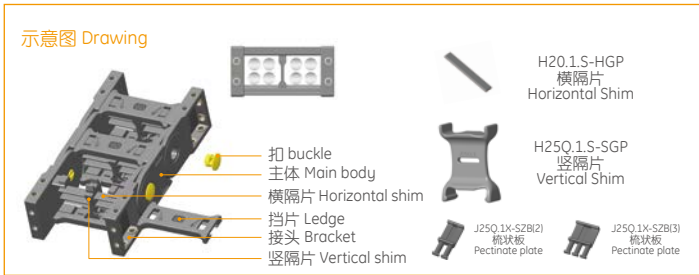

系列号 Series No.	内高 Hi	内宽 Bi	外高 Ha	外宽 Ba	款式 Styles	弯曲半径 Bending radius R	固定接头类型及参数 Bracket type and parameters						代号 No.		
							可配接头类型 Applicable bracket type	孔径 Bore diameter $\phi 1$	孔距 (mm) hole distance						
H25Q.1.38S	25	38	40	57	Q.S	55,75,100, 125,150	F-Q	4.3	16	50.5	57.5	16	9.2	59.5	H25Q.1.38S-FJT
H25Q.1.50S	25	50	40	69	Q.S		F-Q	4.3	16	62.5	57.5	16	9.2	71.5	H25Q.1.50S-FJT
H25Q.1.57S	25	57	40	76	Q.S		F-Q	4.3	16	69.5	57.5	16	9.2	78.5	H25Q.1.57S-FJT
H25Q.1.60S	25	60	40	79	Q.S		F-Q	4.3	16	72.5	57.5	16	9.2	81.5	H25Q.1.60S-FJT
H25Q.1.75S	25	75	40	94	Q.S		F-Q	4.3	16	87.5	57.5	16	9.2	96.5	H25Q.1.75S-FJT
H25Q.1.77S	25	77	40	96	Q.S		F-Q	4.3	16	89.5	57.5	16	9.2	98.5	H25Q.1.77S-FJT
H25Q.1.100S	25	100	40	119	Q.S		F-Q	4.3	16	112.5	57.5	16	9.2	121.5	H25Q.1.100S-FJT
H25Q.1.103S	25	103	40	122	Q.S		F-Q	4.3	16	115.5	57.5	16	9.2	124.5	H25Q.1.103S-FJT
H25Q.1.125S	25	125	40	144	Q.S		F-Q	4.3	16	137.5	57.5	16	9.2	146.5	H25Q.1.125S-FJT

单位 (unit): mm

注: S 表示两侧可打开 Note: S indicates that the both side open

固定接头类型及参数 Fix bracket type and parameters (见表格 See table)



订货示例 Order Example

示例 拖链内高 25、内宽 38、半径 55、长度 1 米 /22 节 (Sample: inner height 25, inner width 38, radius 55, length 1 meter /22 links)

拖链 Chain H25Q.1.38S R55 1000mm /22 Links

接头 Bracket H25Q.1.38S-FJT 1 副 (Set)

配件 Accessories 每节装 1 个竖隔片 /1 个横隔片 (1 vertical shim/1 horizontal shim can be mounted in every link)

注: 可根据客户要求定制各种规格。 Note: Various sizes can be customized according to customer requirements.

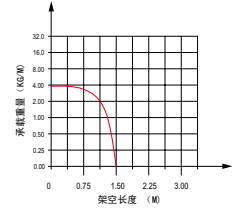
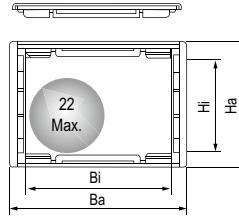
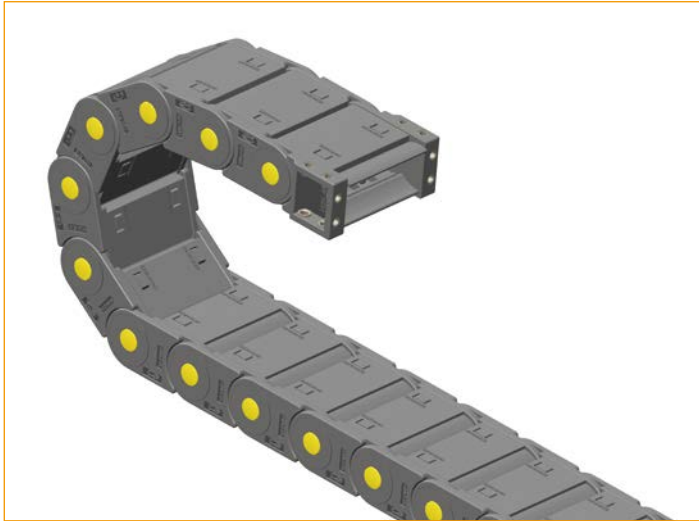

◎ 适用于直径 22 毫米以下线缆 Suitable for 22mm or less of cable.

主要技术参数 Basic technical data

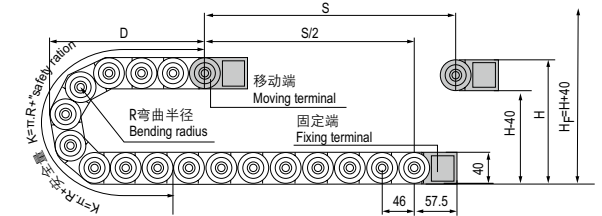

节距 = 46mm, 每米节数 = 22, 链长 = S/2 + K, S = 行程距离, K = π · R + "安全量" + 1 节距
Pitch = 46mm, link per meter = 22, length of chain = S/2 + K, S = stroke. K = π · R + "safety ration" + 1 Pitch

R	75	100	125	150
H	190	240	290	340
D	141	166	191	216
K	368	414	506	598

示意图 Drawing

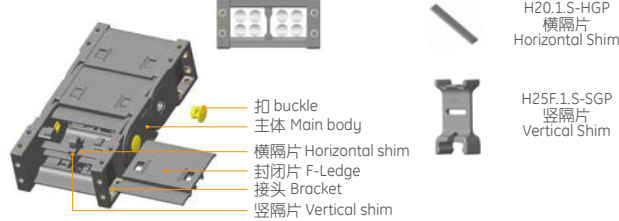

系列号 Series No.	内高 Hi	内宽 Bi	外高 Ha	外宽 Ba	款式 Styles	弯曲半径 Bending radius R	固定接头类型及参数 Bracket type and parameters						代号 No.		
							可配接头类型 Applicable bracket type	孔径 Bore diameter φ1	孔距 (mm) hole distance						
H25F.1.38S	25	38	40	57	F.S	75,100, 125,150	F-F	4.3	16	50.5	57.5	16	9.2	59.5	H25F.1.38S-FJT
H25F.1.50S	25	50	40	69	F.S		F-F	4.3	16	62.5	57.5	16	9.2	71.5	H25F.1.50S-FJT
H25F.1.57S	25	57	40	76	F.S		F-F	4.3	16	69.5	57.5	16	9.2	78.5	H25F.1.57S-FJT
H25F.1.60S	25	60	40	79	F.S		F-F	4.3	16	72.5	57.5	16	9.2	81.5	H25F.1.60S-FJT
H25F.1.75S	25	75	40	94	F.S		F-F	4.3	16	87.5	57.5	16	9.2	96.5	H25F.1.75S-FJT
H25F.1.77S	25	77	40	96	F.S		F-F	4.3	16	89.5	57.5	16	9.2	98.5	H25F.1.77S-FJT
H25F.1.100S	25	100	40	119	F.S		F-F	4.3	16	112.5	57.5	16	9.2	121.5	H25F.1.100S-FJT

单位 (unit): mm

注: S 表示两侧可打开 Note: S indicates that the both side open

固定接头类型及参数 Fix bracket type and parameters (见表格 See table)

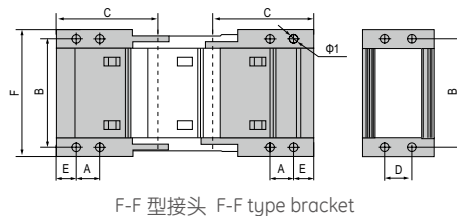

F-F 型接头 F-F type bracket

订货示例 Order Example

示例 拖链内高 25、内宽 50、半径 75、长度 1 米 / 22 节 (Sample: inner height 25, inner width 50, radius 75, length 1 meter / 22 links)

拖链 Chain H25F.1.50S R75 1000mm / 22 Links

接头 Bracket H25F.1.50S-FJT 1 副 (Set)

配件 Accessories 每节装 1 个竖隔片 / 1 个横隔片 (1 vertical shim / 1 horizontal shim can be mounted in every link)

注: 可根据客户要求定制各种规格。 Note: Various sizes can be customized according to customer requirements.

H30Q.1.S 系列 - 桥式两侧可打开

Series of H30Q.1.S-Bridge type open of both side

JFLO[®]

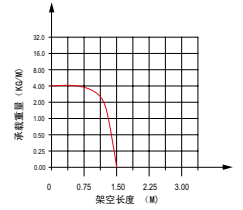
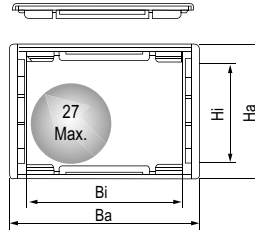
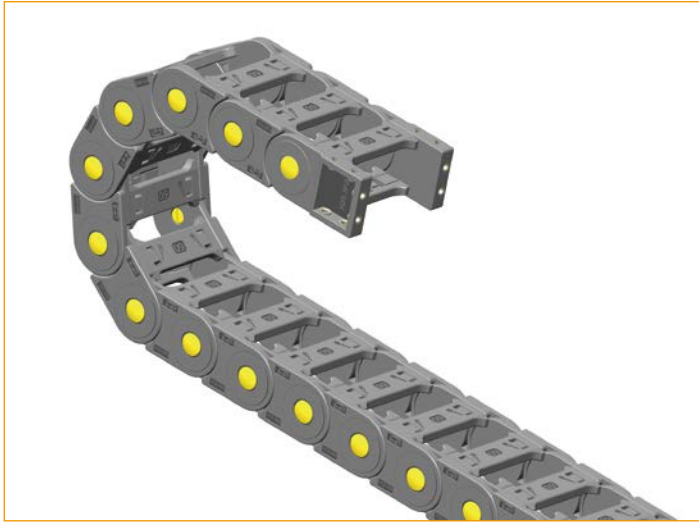

◎ 适用于直径 27 毫米以下线缆 Suitable for 27mm or less of cable.

主要技术参数 Basic technical data

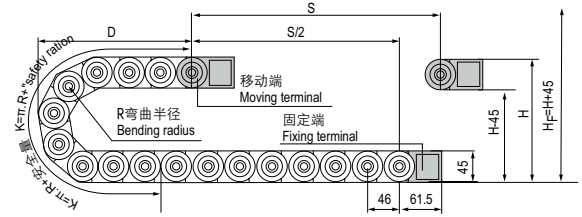

节距=46mm, 每米节数=22, 链长=S/2+K, S=行程距离, K=π.R+"安全量"+1 节距
Pitch=46mm, link per meter=22, length of chain=S/2+K, S=stroke. K=π.R+"safety ration"+1 Pitch

R	55	75	90	100	125	150
H	155	195	225	245	295	345
D	124	144	159	169	194	219
K	276	368	414	460	506	598

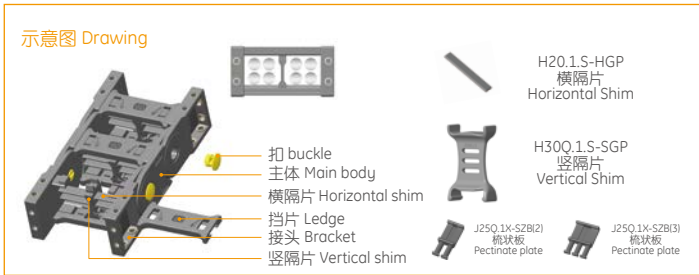

系列号 Series No.	内高 Hi	内宽 Bi	外高 Ha	外宽 Ba	款式 Styles	弯曲半径 Bending radius R	固定接头类型及参数 Bracket type and parameters						代号 No.		
							可配接头类型 Applicable bracket type	孔径 Bore diameter φ1	孔距 (mm)hole distance						
									A	B	C	D		E	F
H30Q.1.38S	30	38	45	60.5	Q.S	55,75,90, 100,125,150	F-Q	5.5	18	52	61.5	18	11	62	H30Q.1.38S-FJT
H30Q.1.50S	30	50	45	72.5	Q.S		F-Q	5.5	18	64	61.5	18	11	74	H30Q.1.50S-FJT
H30Q.1.57S	30	57	45	79.5	Q.S		F-Q	5.5	18	71	61.5	18	11	81	H30Q.1.57S-FJT
H30Q.1.60S	30	60	45	82.5	Q.S		F-Q	5.5	18	74	61.5	18	11	84	H30Q.1.60S-FJT
H30Q.1.75S	30	75	45	97.5	Q.S		F-Q	5.5	18	89	61.5	18	11	99	H30Q.1.75S-FJT
H30Q.1.77S	30	77	45	99.5	Q.S		F-Q	5.5	18	91	61.5	18	11	101	H30Q.1.77S-FJT
H30Q.1.100S	30	100	45	122.5	Q.S		F-Q	5.5	18	114	61.5	18	11	124	H30Q.1.100S-FJT
H30Q.1.103S	30	103	45	125.5	Q.S		F-Q	5.5	18	117	61.5	18	11	127	H30Q.1.103S-FJT
H30Q.1.125S	30	125	45	147.5	Q.S		F-Q	5.5	18	139	61.5	18	11	149	H30Q.1.125S-FJT

单位 (unit): mm

注: S 表示两侧可打开 Note: S indicates that the both side open

固定接头类型及参数 Fix bracket type and parameters (见表格 See table)



订货示例 Order Example

示例 拖链内高 30、内宽 38、半径 75、长度 1 米 /22 节 (Sample: inner height 30, inner width 38, radius 75, length 1 meter /22 links)

拖链 Chain H30Q.1.38S R75 1000mm /22 Links

接头 Bracket H30Q.1.38S-FJT 1 副 (Set)

配件 Accessories 每节装 1 个竖隔片 /1 个横隔片 (1 vertical shim/1 horizontal shim can be mounted in every link)

注: 可根据客户要求定制各种规格。 Note: Various sizes can be customized according to customer requirements.

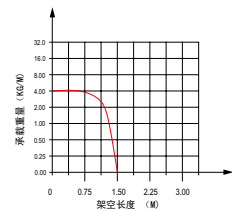
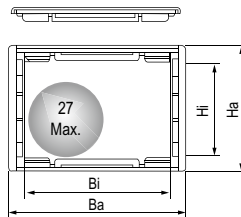

◎ 适用于直径 27 毫米以下线缆 Suitable for 27mm or less of cable.

主要技术参数 Basic technical data

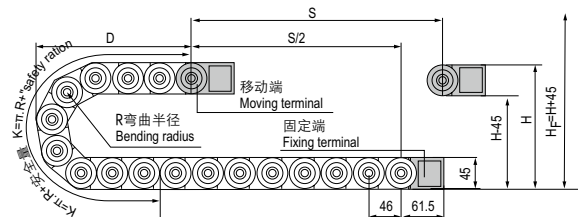

节距 = 46mm, 每米节数 = 22, 链长 = S/2 + K, S = 行程距离, K = π · R + "安全量" + 1 节距
Pitch = 46mm, link per meter = 22, length of chain = S/2 + K, S = stroke, K = π · R + "safety ration" + 1 Pitch

R	75	90	100	125	150
H	195	225	245	295	345
D	144	159	169	194	219
K	368	414	460	506	598

示意图 Drawing

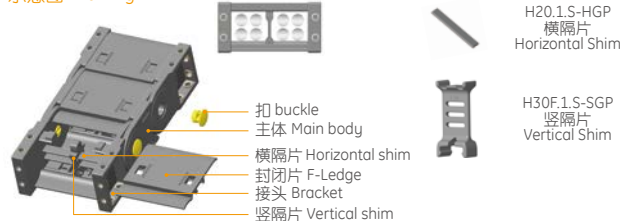

系列号 Series No.	内高 Hi	内宽 Bi	外高 Ha	外宽 Ba	款式 Styles	弯曲半径 Bending radius R	固定接头类型及参数 Bracket type and parameters						代号 No.		
							可配接头类型 Applicable bracket type	孔径 Bore diameter φ1	孔距 (mm) hole distance						
H30F.1.38S	30	38	45	60.5	F.S	75, 90,100, 125,150	F-F	5.5	18	51.5	61.5	18	11	62	H30F.1.38S-FJT
H30F.1.50S	30	50	45	72.5	F.S		F-F	5.5	18	63.5	61.5	18	11	74	H30F.1.50S-FJT
H30F.1.57S	30	57	45	79.5	F.S		F-F	5.5	18	70.5	61.5	18	11	81	H30F.1.57S-FJT
H30F.1.60S	30	60	45	82.5	F.S		F-F	5.5	18	73.5	61.5	18	11	84	H30F.1.60S-FJT
H30F.1.75S	30	75	45	97.5	F.S		F-F	5.5	18	88.5	61.5	18	11	99	H30F.1.75S-FJT
H30F.1.77S	30	77	45	99.5	F.S		F-F	5.5	18	90.5	61.5	18	11	101	H30F.1.77S-FJT
H30F.1.100S	30	100	45	122.5	F.S		F-F	5.5	18	113.5	61.5	18	11	124	H30F.1.100S-FJT

单位 (unit): mm

注: S 表示两侧可打开 Note: S indicates that the both side open

固定接头类型及参数 Fix bracket type and parameters (见表格 See table)

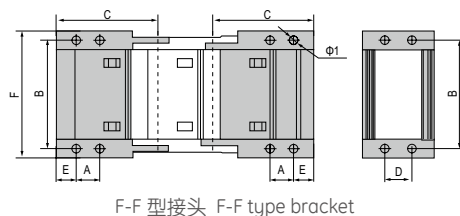

F-F 型接头 F-F type bracket

订货示例 Order Example

示例 拖链内高 30、内宽 50、半径 75、长度 1 米 / 22 节 (Sample: inner height 30, inner width 50, radius 75, length 1 meter / 22 links)

拖链 Chain H30F.1.50S R75 1000mm / 22 Links

接头 Bracket H30F.1.50S-FJT 1 副 (Set)

配件 Accessories 每节装 1 个竖隔片 / 1 个横隔片 (1 vertical shim / 1 horizontal shim can be mounted in every link)

注: 可根据客户要求定制各种规格。 Note: Various sizes can be customized according to customer requirements.

H35Q.1.S 系列 - 桥式两侧可打开

Series of H35Q.1.S-Bridge type open of both side

JFLO[®]

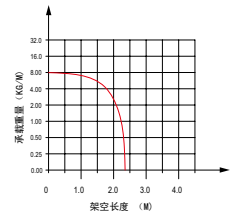
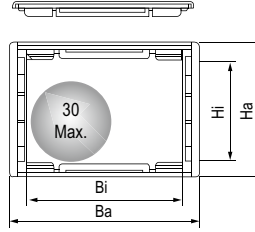
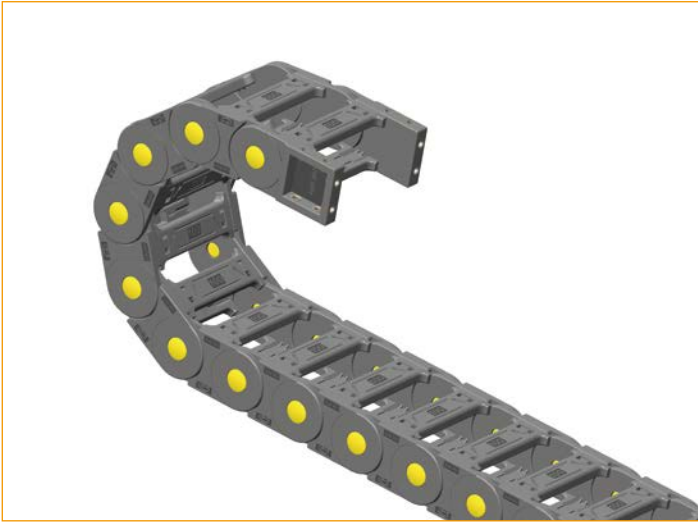

◎ 适用于直径 30 毫米以下线缆 Suitable for 30mm or less of cable.

主要技术参数 Basic technical data

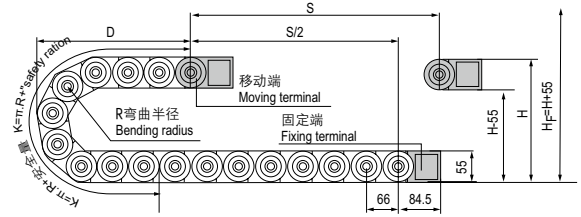

节距 =66mm, 每米节数=15, 链长 =S/2+K, S=行程距离, K=π.R+ "安全量"+1 节距
Pitch=66mm, link per meter=15, length of chain=S/2+K, S=stroke. K=π.R+ "safety ration"+1 Pitch

R	75	100	125	150	175	200	250	300
H	205	255	305	355	405	455	555	655
D	169	194	219	244	267	294	344	394
K	396	462	528	660	726	792	924	1122

示意图 Drawing

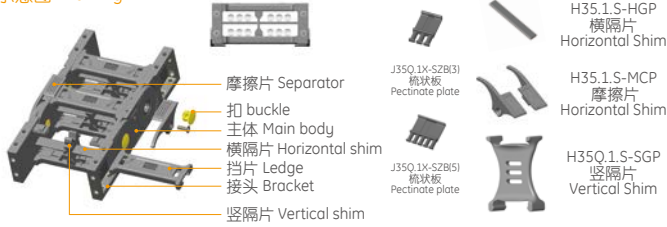

系列号 Series No.	内高 Hi	内宽 Bi	外高 Ha	外宽 Ba	款式 Styles	弯曲半径 Bending radius R	固定接头类型及参数 Bracket type and parameters						代号 No.		
							可配接头类型 Applicable bracket type	孔径 Bore diameter Φ1	孔距 (mm)hole distance						
							A	B	C	D	E	F			
H35Q.1.50S	35	50	55	76	Q.S	75,100,125, 150,175,200, 250,300	F-Q	6	24	66	84.5	26	16	78	H35Q.1.50S-FJT
H35Q.1.60S	35	60	55	86	Q.S		F-Q	6	24	76	84.5	26	16	88	H35Q.1.60S-FJT
H35Q.1.75S	35	75	55	101	Q.S		F-Q	6	24	91	84.5	26	16	103	H35Q.1.75S-FJT
H35Q.1.90S	35	90	55	116	Q.S		F-Q	6	24	106	84.5	26	16	118	H35Q.1.90S-FJT
H35Q.1.100S	35	100	55	126	Q.S		F-Q	6	24	116	84.5	26	16	128	H35Q.1.100S-FJT
H35Q.1.117S	35	117	55	143	Q.S		F-Q	6	24	133	84.5	26	16	145	H35Q.1.117S-FJT
H35Q.1.125S	35	125	55	151	Q.S		F-Q	6	24	141	84.5	26	16	153	H35Q.1.125S-FJT
H35Q.1.130S	35	130	55	156	Q.S		F-Q	6	24	146	84.5	26	16	158	H35Q.1.130S-FJT
H35Q.1.150S	35	150	55	176	Q.S		F-Q	6	24	166	84.5	26	16	178	H35Q.1.150S-FJT
H35Q.1.154S	35	154	55	180	Q.S		F-Q	6	24	170	84.5	26	16	182	H35Q.1.154S-FJT
H35Q.1.175S	35	175	55	201	Q.S		F-Q	6	24	191	84.5	26	16	203	H35Q.1.175S-FJT
H35Q.1.200S	35	200	55	226	Q.S		F-Q	6	24	216	84.5	26	16	228	H35Q.1.200S-FJT
H35Q.1.250S	35	250	55	276	Q.S	F-Q	6	24	266	84.5	26	16	278	H35Q.1.250S-FJT	
H35Q.1.300S	35	300	55	326	Q.S	F-Q	6	24	316	84.5	26	16	328	H35Q.1.300S-FJT	

注: S 表示两侧可打开 Note: S indicates that the both side open

单位 (unit): mm

固定接头类型及参数 Fix bracket type and parameters (见表格 See table)

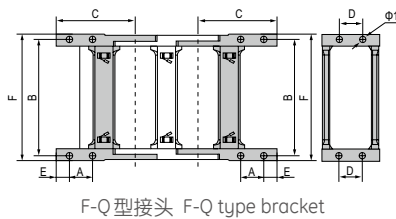

F-Q 型接头 F-Q type bracket

订货示例 Order Example

示例 拖链内高 30、内宽 50、半径 75、长度 1 米 /15 节 (Sample: inner height 30, inner width 50 radius 75, length 15 links/1 meter)

拖链 Chain H35Q.1.50S R75 1000mm/15 Links

接头 Bracket H35Q.1.50S-FJT 1 副 (Set)

配件 Accessories 每节装 1 个竖隔片 /1 个横隔片 (1 vertical shim/1 horizontal shim can be mounted in every link)

注: 可根据客户要求定制各种规格。 Note: Various sizes can be customized according to customer requirements.

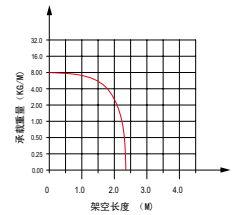
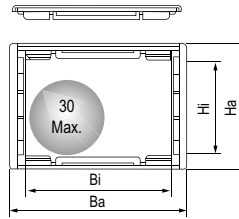
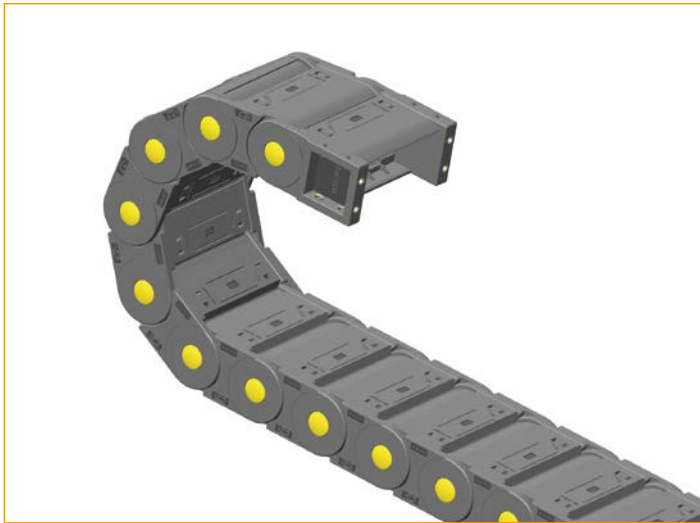

◎ 适用于直径 30 毫米以下线缆 Suitable for 30mm or less of cable.

主要技术参数 Basic technical data

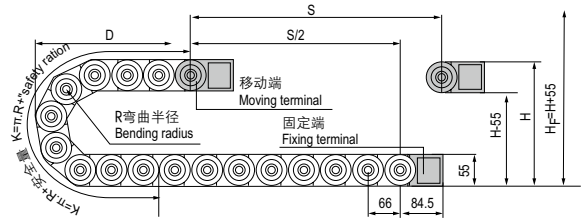

节距 =66mm, 每米节数 =15, 链长 =S/2+K, S=行程距离, K=π.R+"安全量"+1 节距
Pitch=66mm, link per meter=15, length of chain=S/2+K, S=stroke. K=π.R+"safety ration"+1 Pitch

R	100	125	150	175	200	250	300
H	255	305	355	405	455	555	655
D	194	219	244	267	294	344	394
K	462	528	660	726	792	924	1122

示意图 Drawing

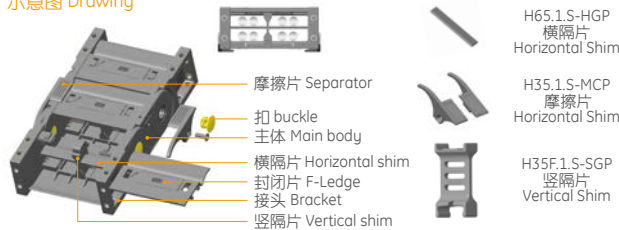

系列号 Series No.	内高 Hi	内宽 Bi	外高 Ha	外宽 Ba	款式 Styles	弯曲半径 Bending radius R	固定接头类型及参数 Bracket type and parameters						代号 No.		
							可配接头类型 Applicable bracket type	孔径 Bore diameter φ1	孔距 (mm) hole distance					A	B
H35F.1.50S	35	50	55	76	F.S	100,125, 150,175,200 250,300	F-F	6	24	66	84.5	26	16		
H35F.1.60S	35	60	55	86	F.S		F-F	6	24	76	84.5	26	16	88	H35F.1.60S-FJT
H35F.1.75S	35	75	55	101	F.S		F-F	6	24	91	84.5	26	16	103	H35F.1.75S-FJT
H35F.1.100S	35	100	55	126	F.S		F-F	6	24	116	84.5	26	16	128	H35F.1.100S-FJT
H35F.1.125S	35	125	55	151	F.S		F-F	6	24	141	84.5	26	16	153	H35F.1.125S-FJT
H35F.1.130S	35	130	55	156	F.S		F-F	6	24	146	84.5	26	16	158	H35F.1.130S-FJT
H35F.1.150S	35	150	55	176	F.S		F-F	6	24	166	84.5	26	16	178	H35F.1.150S-FJT

单位 (unit): mm

注: S 表示两侧可打开 Note: S indicates that the both side open

固定接头类型及参数 Fix bracket type and parameters (见表格 See table)

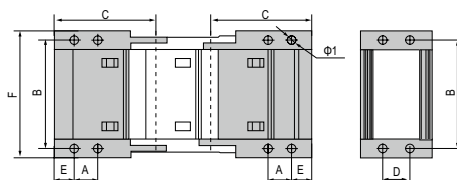

F-F 型接头 F-F type bracket

订货示例 Order Example

示例 拖链内高 35、内宽 50、半径 75、长度 1 米 /15 节 (Sample: inner height 35, inner width 50 radius 75, length 15 links/1 meter)

拖链 Chain H35F.1.50S R75 1000mm /15 Links

接头 Bracket H35F.1.50S-FJT 1 副 (Set)

配件 Accessories 每节装 1 个竖隔片 /1 个横隔片 (1 vertical shim/1 horizontal shim can be mounted in every link)

注: 可根据客户要求定制各种规格。 Note: Various sizes can be customized according to customer requirements.

H45Q.1.S 系列 - 桥式两侧可打开

Series of H45Q.1.S-Bridge type open of both side

JFLO[®]

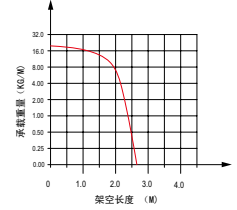
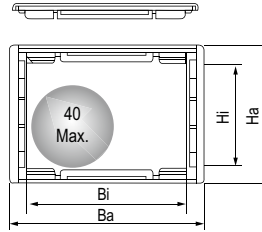
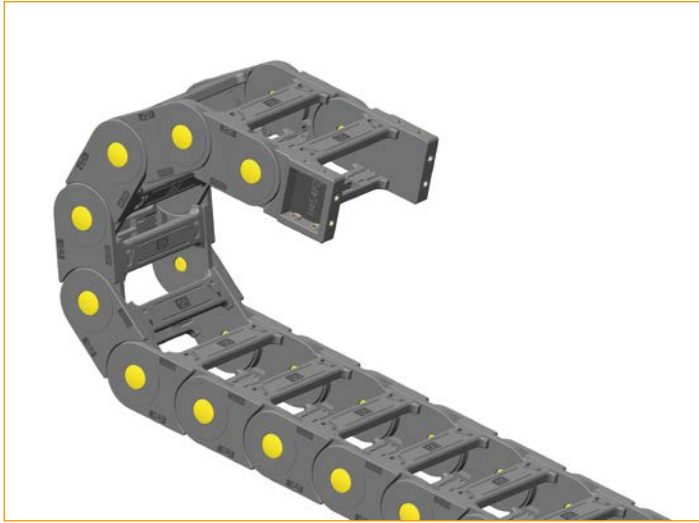

◎ 适用于直径 40 毫米以下线缆 Suitable for 40mm or less of cable.

主要技术参数 Basic technical data

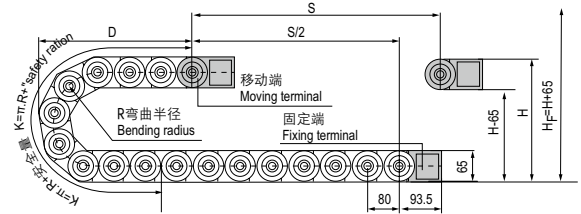

节距 = 80mm, 每米节数 = 13, 链长 = S/2 + K, S = 行程距离, K = π · R + "安全量" + 1 节距
Pitch = 80mm, link per meter = 13, length of chain = S/2 + K, S = stroke, K = π · R + "safety ration" + 1 Pitch

R	75	100	125	150	175	200	250	300
H	215	265	315	365	415	465	565	665
D	188	213	238	263	288	313	363	413
K	400	480	560	640	720	800	960	1120

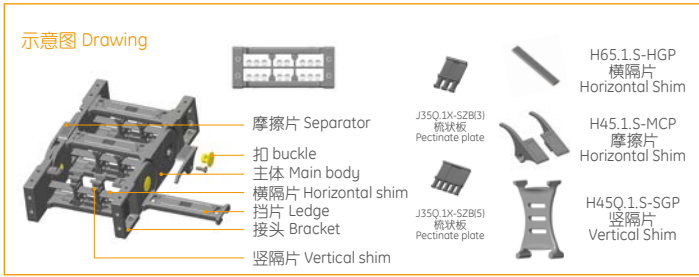

系列号 Series No.	内高 Hi	内宽 Bi	外高 Ha	外宽 Ba	款式 Styles	弯曲半径 Bending radius R	固定接头类型及参数 Bracket type and parameters						代号 No.		
							可配接头类型 Applicable bracket type	孔径 Bore diameter Φ1	孔距 (mm) hole distance						
H45Q.1.50S	45	50	65	80	Q.S	75,100,125, 150,175,200, 250,300	F-Q	6	23.5	68	93.5	25.5	16	83.5	H45Q.1.50S-FJT
H45Q.1.60S	45	60	65	90	Q.S		F-Q	6	23.5	78	93.5	25.5	16	93.5	H45Q.1.60S-FJT
H45Q.1.75S	45	75	65	105	Q.S		F-Q	6	23.5	93	93.5	25.5	16	108.5	H45Q.1.75S-FJT
H45Q.1.90S	45	90	65	120	Q.S		F-Q	6	23.5	108	93.5	25.5	16	123.5	H45Q.1.90S-FJT
H45Q.1.100S	45	100	65	130	Q.S		F-Q	6	23.5	118	93.5	25.5	16	133.5	H45Q.1.100S-FJT
H45Q.1.117S	45	117	65	147	Q.S		F-Q	6	23.5	135	93.5	25.5	16	150.5	H45Q.1.117S-FJT
H45Q.1.125S	45	125	65	155	Q.S		F-Q	6	23.5	143	93.5	25.5	16	158.5	H45Q.1.125S-FJT
H45Q.1.130S	45	130	65	160	Q.S		F-Q	6	23.5	148	93.5	25.5	16	163.5	H45Q.1.130S-FJT
H45Q.1.150S	45	150	65	180	Q.S		F-Q	6	23.5	168	93.5	25.5	16	183.5	H45Q.1.150S-FJT
H45Q.1.154S	45	154	65	184	Q.S		F-Q	6	23.5	172	93.5	25.5	16	187.5	H45Q.1.154S-FJT
H45Q.1.175S	45	175	65	205	Q.S		F-Q	6	23.5	193	93.5	25.5	16	208.5	H45Q.1.175S-FJT
H45Q.1.200S	45	200	65	230	Q.S		F-Q	6	23.5	218	93.5	25.5	16	233.5	H45Q.1.200S-FJT
H45Q.1.250S	45	250	65	280	Q.S		F-Q	6	23.5	268	93.5	25.5	16	283.5	H45Q.1.250S-FJT
H45Q.1.300S	45	300	65	330	Q.S		F-Q	6	23.5	318	93.5	25.5	16	333.5	H45Q.1.300S-FJT

注: S 表示两侧可打开 Note: S indicates that the both side open

单位 (unit): mm

固定接头类型及参数 Fix bracket type and parameters (见表格 See table)



订货示例 Order Example

示例 拖链内高 45、内宽 50、半径 75、长度 1 米 / 13 节 (Sample: inner height 45, inner width 50, radius 75, length 13 links/1 meter)

拖链 Chain H45Q.1.50S R75 1000mm / 13 Links

接头 Bracket H45Q.1.50S-FJT 1 副 (Set)

配件 Accessories 每节装 1 个竖隔片 / 1 个横隔片 (1 vertical shim/1 horizontal shim can be mounted in every link)

注: 可根据客户要求定制各种规格。 Note: Various sizes can be customized according to customer requirements.

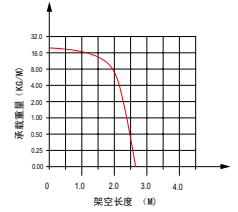
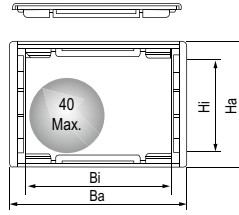
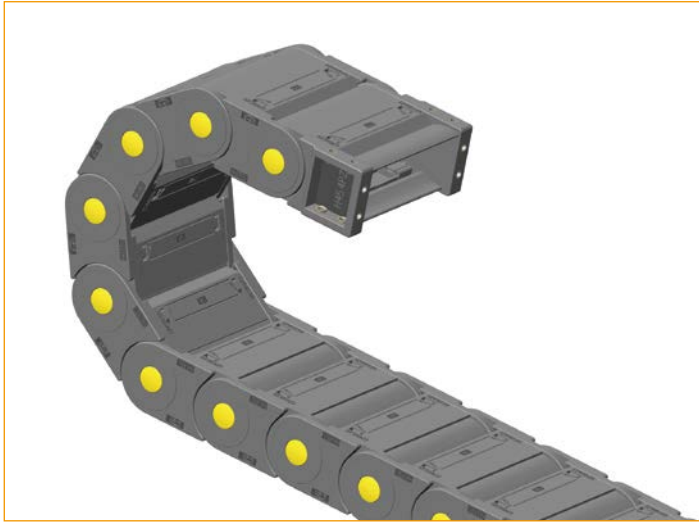

◎ 适用于直径 40 毫米以下线缆 Suitable for 40mm or less of cable.

主要技术参数 Basic technical data

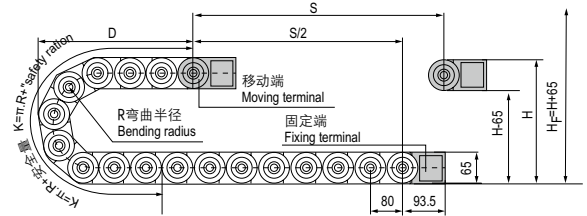

节距 = 80mm, 每米节数 = 13, 链长 = S/2 + K, S = 行程距离, K = π · R + "安全量" + 1 节距
Pitch = 80mm, link per meter = 13, length of chain = S/2 + K, S = stroke, K = π · R + "safety ration" + 1 Pitch

R	100	125	150	175	200	250	300
H	265	315	365	415	465	565	665
D	213	238	263	288	313	363	413
K	480	560	640	720	800	960	1120

示意图 Drawing

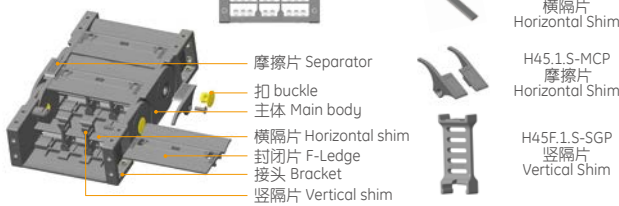

系列号 Series No.	内高 Hi	内宽 Bi	外高 Ha	外宽 Ba	款式 Styles	弯曲半径 Bending radius R	固定接头类型及参数 Bracket type and parameters						代号 No.		
							可配接头类型 Applicable bracket type	孔径 Bore diameter φ1	孔距 (mm) hole distance						
							A	B	C	D	E	F			
H45F.1.50S	45	50	65	80	F.S	100,125,150, 175,200,250, 300	F-F	6	23.5	68	93.5	25.5	16	83.5	H45F.1.50S-FJT
H45F.1.60S	45	60	65	90	F.S		F-F	6	23.5	78	93.5	25.5	16	93.5	H45F.1.60S-FJT
H45F.1.75S	45	75	65	105	F.S		F-F	6	23.5	93	93.5	25.5	16	108.5	H45F.1.75S-FJT
H45F.1.90S	45	90	65	120	F.S		F-F	6	23.5	108	93.5	25.5	16	123.5	H45F.1.90S-FJT
H45F.1.100S	45	100	65	130	F.S		F-F	6	23.5	118	93.5	25.5	16	133.5	H45F.1.100S-FJT
H45F.1.125S	45	125	65	155	F.S		F-F	6	23.5	143	93.5	25.5	16	158.5	H45F.1.125S-FJT
H45F.1.130S	45	130	65	160	F.S		F-F	6	23.5	148	93.5	25.5	16	163.5	H45F.1.130S-FJT
H45F.1.150S	45	150	65	180	F.S		F-F	6	23.5	168	93.5	25.5	16	183.5	H45F.1.150S-FJT
H45F.1.175S	45	175	65	205	F.S		F-F	6	23.5	193	93.5	25.5	16	208.5	H45F.1.175S-FJT
H45F.1.200S	45	200	65	230	F.S		F-F	6	23.5	218	93.5	25.5	16	233.5	H45F.1.200S-FJT

单位 (unit): mm

注: S 表示两侧可打开 Note: S indicates that the both side open

固定接头类型及参数 Fix bracket type and parameters (见表格 See table)



订货示例 Order Example

示例 拖链内高 45、内宽 60、半径 100、长度 1 米 / 13 节 (Sample: inner height 45, inner width 60, radius 100, length 13 links/1 meter)

拖链 Chain H45F.1.60S R100 1000mm / 13 Links

接头 Bracket H45F.1.60S-FJT 1 副 (Set)

配件 Accessories 每节装 1 个竖隔片 / 1 个横隔片 (1 vertical shim / 1 horizontal shim can be mounted in every link)

注: 可根据客户要求定制各种规格。 Note: Various sizes can be customized according to customer requirements.

H55Q.1.S 系列 - 桥式两侧可打开

Series of H55Q.1.S-Bridge type open of both side

JFLO[®]

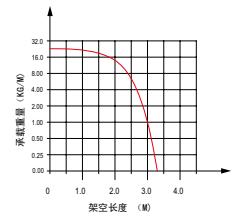
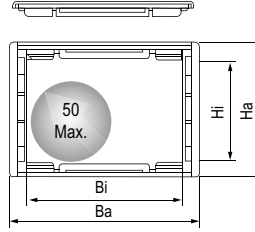
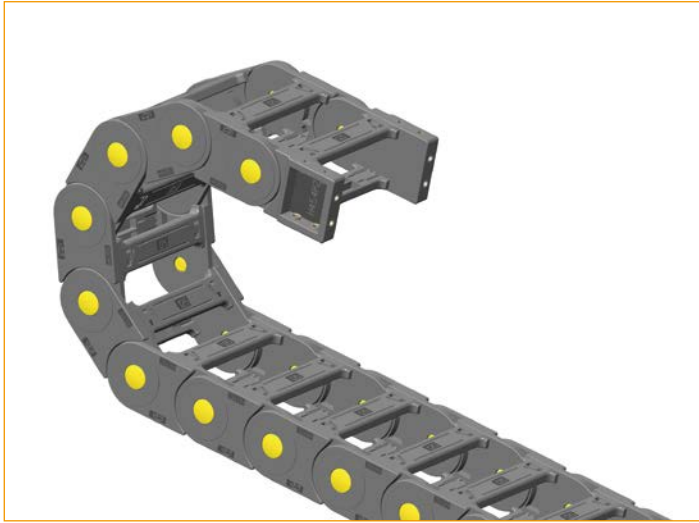

◎ 适用于直径 50 毫米以下线缆 Suitable for 50mm or less of cable.

主要技术参数 Basic technical data

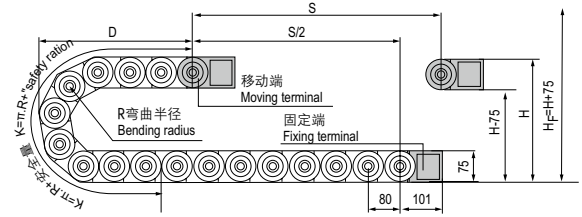

节距=80mm, 每米节数=13, 链长=S/2+K, S=行程距离, K=π·R+“安全量”+1 节距
Pitch=80mm, link per meter=13, length of chain=S/2+K, S=stroke. K=π·R+“safety ration”+1 Pitch

R	75	100	125	150	200	250	300
H	225	275	325	375	475	575	675
D	193	218	243	268	318	368	418
K	400	480	560	640	800	960	1120

示意图 Drawing

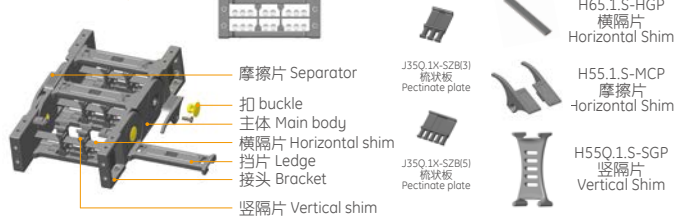

系列号 Series No.	内高 Hi	内宽 Bi	外高 Ha	外宽 Ba	款式 Styles	弯曲半径 Bending radius R	固定接头类型及参数 Bracket type and parameters						代号 No.		
							可配接头类型 Applicable bracket type	孔径 Bore diameter Φ1	孔距 (mm)hole distance						
H55Q.1.50S	55	50	75	83	Q.S	75,100,125, 150,200,250, 300	F-Q	6	30	69	101	30	17	84.5	H55Q.1.50S-FJT
H55Q.1.60S	55	60	75	93	Q.S		F-Q	6	30	79	101	30	17	94.5	H55Q.1.60S-FJT
H55Q.1.75S	55	75	75	108	Q.S		F-Q	6	30	94	101	30	17	109.5	H55Q.1.75S-FJT
H55Q.1.90S	55	90	75	123	Q.S		F-Q	6	30	109	101	30	17	124.5	H55Q.1.90S-FJT
H55Q.1.100S	55	100	75	133	Q.S		F-Q	6	30	119	101	30	17	134.5	H55Q.1.100S-FJT
H55Q.1.117S	55	117	75	150	Q.S		F-Q	6	30	136	101	30	17	151.5	H55Q.1.117S-FJT
H55Q.1.125S	55	125	75	158	Q.S		F-Q	6	30	144	101	30	17	159.5	H55Q.1.125S-FJT
H55Q.1.130S	55	130	75	163	Q.S		F-Q	6	30	149	101	30	17	164.5	H55Q.1.130S-FJT
H55Q.1.150S	55	150	75	183	Q.S		F-Q	6	30	169	101	30	17	184.5	H55Q.1.150S-FJT
H55Q.1.154S	55	154	75	187	Q.S		F-Q	6	30	173	101	30	17	188.5	H55Q.1.154S-FJT
H55Q.1.175S	55	175	75	208	Q.S		F-Q	6	30	194	101	30	17	209.5	H55Q.1.175S-FJT
H55Q.1.200S	55	200	75	233	Q.S		F-Q	6	30	219	101	30	17	234.5	H55Q.1.200S-FJT
H55Q.1.250S	55	250	75	283	Q.S		F-Q	6	30	269	101	30	17	284.5	H55Q.1.250S-FJT
H55Q.1.300S	55	300	75	333	Q.S		F-Q	6	30	319	101	30	17	334.5	H55Q.1.300S-FJT

注: S 表示两侧可打开 Note: S indicates that the both side open

单位 (unit): mm

固定接头类型及参数 Fix bracket type and parameters (见表格 See table)



订货示例 Order Example

示例 拖链内高 55、内宽 50、半径 75、长度 1 米 /13 节 (Sample: inner height 55, inner width 50, radius 75, length 13 links/1 meter)

拖链 Chain H55Q.1.50S R75 1000mm /13 Links

接头 Bracket H55Q.1.50S-FJT 1 副 (Set)

配件 Accessories 每节装 1 个竖隔片 /1 个横隔片 (1 vertical shim/1 horizontal shim can be mounted in every link)

注: 可根据客户要求定制各种规格。 Note: Various sizes can be customized according to customer requirements.

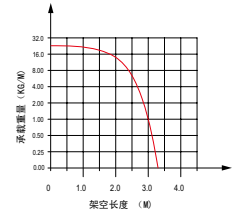
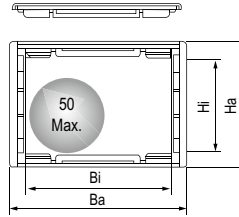
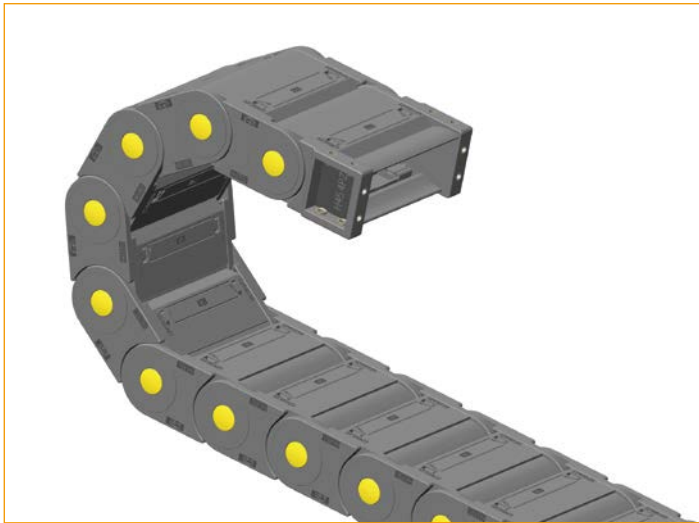

◎ 适用于直径 50 毫米以下线缆 Suitable for 50mm or less of cable.

主要技术参数 Basic technical data

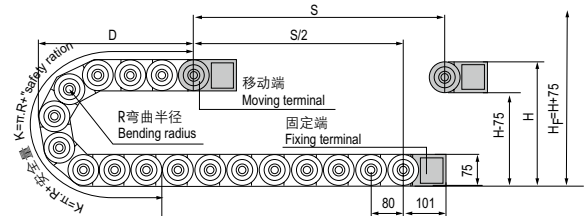

节距 = 80mm, 每米节数 = 13, 链长 = S/2 + K, S = 行程距离, K = π · R + "安全量" + 1 节距
Pitch = 80mm, link per meter = 13, length of chain = S/2 + K, S = stroke, K = π · R + "safety ration" + 1 Pitch

R	125	150	200	250	300
H	325	375	475	575	675
D	243	268	318	368	418
K	560	640	800	960	1120

示意图 Drawing

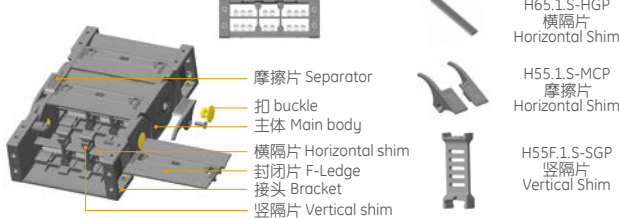

系列号 Series No.	内高 Hi	内宽 Bi	外高 Ha	外宽 Ba	款式 Styles	弯曲半径 Bending radius R	固定接头类型及参数 Bracket type and parameters						代号 No.		
							可配接头类型 Applicable bracket type	孔径 Bore diameter φ1	孔距 (mm) hole distance						
H55F.1.50S	55	50	75	83	F.S	125,150 200,250,300	F-F	6	30	69	101	30	17	84.5	H55F.1.50S-FJT
H55F.1.60S	55	60	75	93	F.S		F-F	6	30	79	101	30	17	94.5	H55F.1.60S-FJT
H55F.1.75S	55	75	75	108	F.S		F-F	6	30	94	101	30	17	109.5	H55F.1.75S-FJT
H55F.1.90S	55	90	75	123	F.S		F-F	6	30	109	101	30	17	124.5	H55F.1.90S-FJT
H55F.1.100S	55	100	75	133	F.S		F-F	6	30	119	101	30	17	134.5	H55F.1.100S-FJT
H55F.1.125S	55	125	75	158	F.S		F-F	6	30	144	101	30	17	159.5	H55F.1.125S-FJT
H55F.1.130S	55	130	75	163	F.S		F-F	6	30	149	101	30	17	164.5	H55F.1.130S-FJT
H55F.1.150S	55	150	75	183	F.S		F-F	6	30	169	101	30	17	184.5	H55F.1.150S-FJT
H55F.1.175S	55	175	75	208	F.S		F-F	6	30	194	101	30	17	209.5	H55F.1.175S-FJT
H55F.1.200S	55	200	75	233	F.S		F-F	6	30	219	101	30	17	234.5	H55F.1.200S-FJT

单位 (unit): mm

注: S 表示两侧可打开 Note: S indicates that the both side open

固定接头类型及参数 Fix bracket type and parameters (见表格 See table)

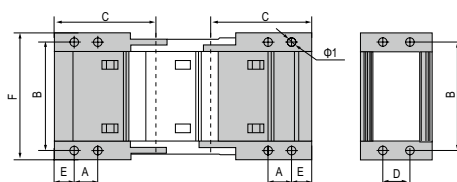

F-F 型接头 F-F type bracket

订货示例 Order Example

示例 拖链内高 55、内宽 60、半径 100、长度 1 米 / 13 节 (Sample: inner height 55, inner width 60, radius 100, length 13 links/1 meter)

拖链 Chain H55F.1.60S R100 1000mm / 13 Links

接头 Bracket H55F.1.60S-FJT 1 副 (Set)

配件 Accessories 每节装 1 个竖隔片 / 1 个横隔片 (1 vertical shim/1 horizontal shim can be mounted in every link)

注: 可根据客户要求定制各种规格。 Note: Various sizes can be customized according to customer requirements.

H65Q.1.S 系列 - 桥式两侧可打开

Series of H65Q.1.S-Bridge type open of both side

JFLO[®]

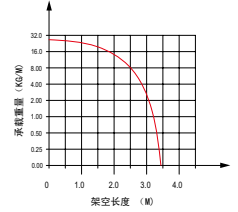
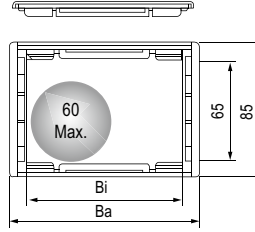

◎ 适用于直径 60 毫米以下线缆 Suitable for 60mm or less of cable.

主要技术参数 Basic technical data

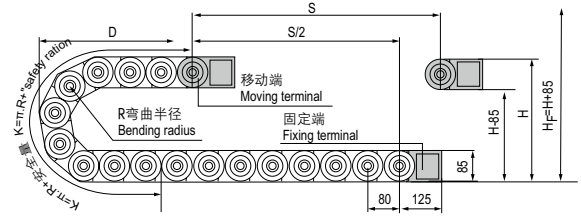

节距 = 80mm, 每米节数 = 13, 链长 = S/2 + K, S = 行程距离, K = π · R + "安全量" + 1 节距
Pitch = 80mm, link per meter = 13, length of chain = S/2 + K, S = stroke. K = π · R + "safety ration" + 1 Pitch

R	125	150	200	250	300	400	500
H	335	385	485	585	685	885	1085
D	248	273	323	383	423	523	623
K	560	640	800	960	1120	1440	1760

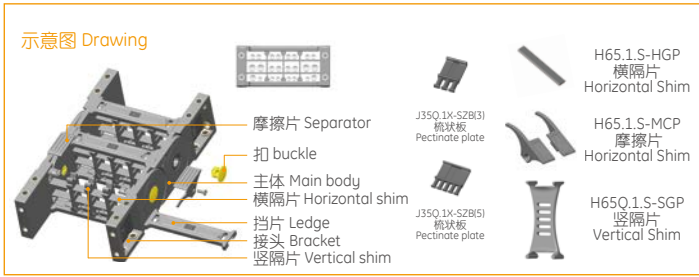

系列号 Series No.	内高 Hi	内宽 Bi	外高 Ha	外宽 Ba	款式 Styles	弯曲半径 Bending radius R	固定接头类型及参数 Bracket type and parameters						代号 No.		
							可配接头类型 Applicable bracket type	孔径 Bore diameter Φ1	孔距 (mm) hole distance						
H65Q.1.50S	65	50	85	85.5	Q.S	125, 150, 200, 250, 300, 400, 500	F-Q	9	35	72	125	45	20	89.5	H65Q.1.50S-FJT
H65Q.1.60S	65	60	85	95.5	Q.S		F-Q	9	35	82	125	45	20	99.5	H65Q.1.60S-FJT
H65Q.1.75S	65	75	85	110.5	Q.S		F-Q	9	35	97	125	45	20	114.5	H65Q.1.75S-FJT
H65Q.1.90S	65	90	85	125.5	Q.S		F-Q	9	35	112	125	45	20	129.5	H65Q.1.90S-FJT
H65Q.1.100S	65	100	85	135.5	Q.S		F-Q	9	35	122	125	45	20	139.5	H65Q.1.100S-FJT
H65Q.1.117S	65	117	85	152.5	Q.S		F-Q	9	35	139	125	45	20	156.5	H65Q.1.117S-FJT
H65Q.1.125S	65	125	85	160.5	Q.S		F-Q	9	35	147	125	45	20	164.5	H65Q.1.125S-FJT
H65Q.1.130S	65	130	85	165.5	Q.S		F-Q	9	35	152	125	45	20	169.5	H65Q.1.130S-FJT
H65Q.1.150S	65	150	85	185.5	Q.S		F-Q	9	35	172	125	45	20	189.5	H65Q.1.150S-FJT
H65Q.1.154S	65	154	85	189.5	Q.S		F-Q	9	35	176	125	45	20	193.5	H65Q.1.154S-FJT
H65Q.1.175S	65	175	85	210.5	Q.S		F-Q	9	35	197	125	45	20	214.5	H65Q.1.175S-FJT
H65Q.1.200S	65	200	85	235.5	Q.S		F-Q	9	35	222	125	45	20	239.5	H65Q.1.200S-FJT
H65Q.1.250S	65	250	85	285.5	Q.S		F-Q	9	35	272	125	45	20	289.5	H65Q.1.250S-FJT
H65Q.1.300S	65	300	85	335.5	Q.S		F-Q	9	35	322	125	45	20	339.5	H65Q.1.300S-FJT

注: S 表示两侧可打开 Note: S indicates that the both side open

单位 (unit): mm

固定接头类型及参数 Fix bracket type and parameters (见表格 See table)



订货示例 Order Example

示例 拖链内高 65、内宽 50、半径 125、长度 1 米 / 13 节 (Sample: inner height 65, inner width 50, radius 125, length 13 links/1 meter)

拖链 Chain H65Q.1.50S R125 1000mm / 13 Links

接头 Bracket H65Q.1.50S-FJT 1 副 (Set)

配件 Accessories 每节装 1 个竖隔片 / 1 个横隔片 (1 vertical shim/1 horizontal shim can be mounted in every link)

注: 可根据客户要求定制各种规格。 Note: Various sizes can be customized according to customer requirements.

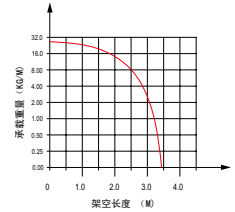
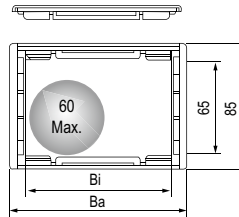
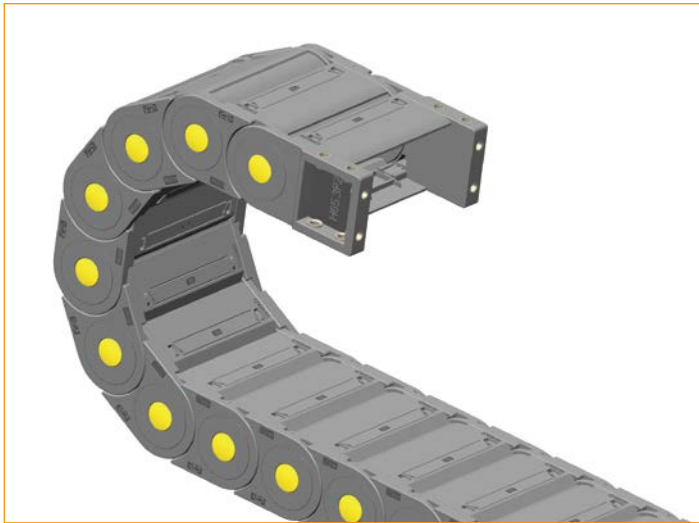

◎ 适用于直径 60 毫米以下线缆 Suitable for 60mm or less of cable.

主要技术参数 Basic technical data

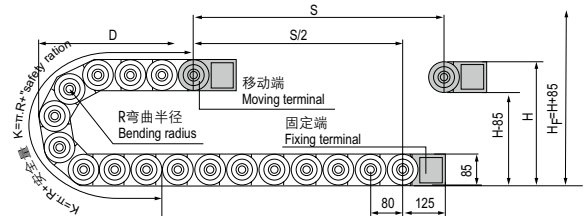

节距 = 80mm, 每米节数 = 13, 链长 = S/2 + K, S = 行程距离, K = π · R + "安全量" + 1 节距
Pitch = 80mm, link per meter = 13, length of chain = S/2 + K, S = stroke, K = π · R + "safety ration" + 1 Pitch

R	125	150	200	250	300	400	500
H	335	385	485	585	685	885	1085
D	248	273	323	383	423	523	623
K	560	640	800	960	1120	1440	1760

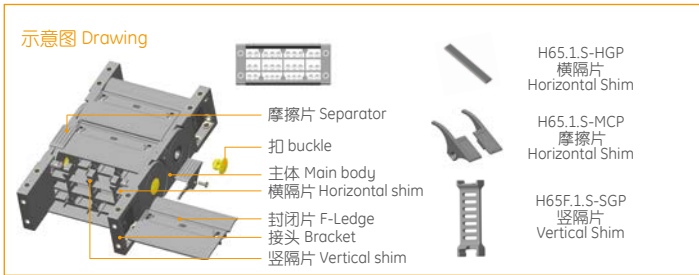

系列号 Series No.	内高 Hi	内宽 Bi	外高 Ha	外宽 Ba	款式 Styles	弯曲半径 Bending radius R	固定接头类型及参数 Bracket type and parameters						代号 No.		
							可配接头类型 Applicable bracket type	孔径 Bore diameter φ1	孔距 (mm) hole distance						
H65F.1.50S	65	50	85	85.5	F.S	125,150 200,250,300 400,500	F-F	9	35	72	125	45	20	89.5	H65F.1.50S-FJT
H65F.1.60S	65	60	85	95.5	F.S		F-F	9	35	82	125	45	20	99.5	H65F.1.60S-FJT
H65F.1.75S	65	75	85	110.5	F.S		F-F	9	35	97	125	45	20	114.5	H65F.1.75S-FJT
H65F.1.90S	65	90	85	125.5	F.S		F-F	9	35	112	125	45	20	129.5	H65F.1.90S-FJT
H65F.1.100S	65	100	85	135.5	F.S		F-F	9	35	122	125	45	20	139.5	H65F.1.100S-FJT
H65F.1.125S	65	125	85	160.5	F.S		F-F	9	35	147	125	45	20	164.5	H65F.1.125S-FJT
H65F.1.130S	65	130	85	165.5	F.S		F-F	9	35	152	125	45	20	169.5	H65F.1.130S-FJT
H65F.1.150S	65	150	85	185.5	F.S		F-F	9	35	172	125	45	20	189.5	H65F.1.150S-FJT
H65F.1.175S	65	175	85	210.5	F.S		F-F	9	35	197	125	45	20	214.5	H65F.1.175S-FJT
H65F.1.200S	65	200	85	235.5	F.S		F-F	9	35	222	125	45	20	239.5	H65F.1.200S-FJT

注: S 表示两侧可打开 Note: S indicates that the both side open

固定接头类型及参数 Fix bracket type and parameters (见表格 See table)

单位 (unit): mm

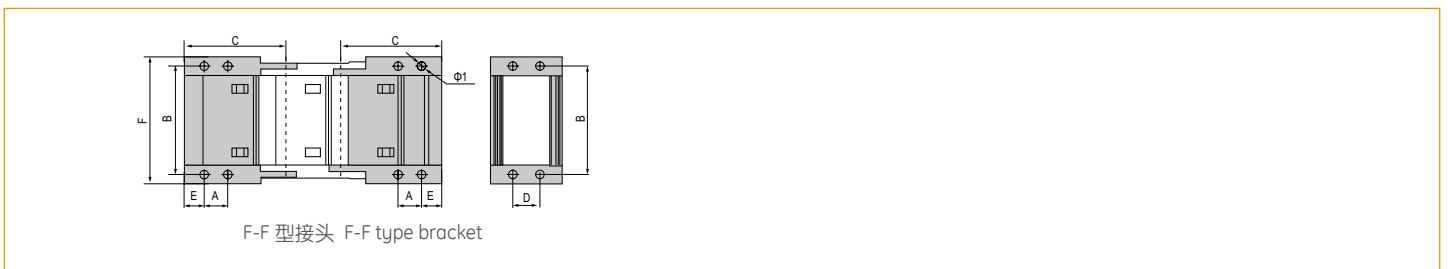

订货示例 Order Example

示例 拖链内高 65、内宽 60、半径 125、长度 1 米 /13 节 (Sample: inner height 65, inner width 60, radius 125, length 13 links/1 meter)

拖链 Chain H65F.1.60S R125 1000mm /13 Links

接头 Bracket H65F.1.60S-FJT 1 副 (Set)

配件 Accessories 每节装 1 个竖隔片 /1 个横隔片 (1 vertical shim/1 horizontal shim can be mounted in every link)

注: 可根据客户要求定制各种规格。 Note: Various sizes can be customized according to customer requirements.

H80Q.1.S 系列 - 桥式两侧可打开

Series of H80Q.1.S-Bridge type open of both side

JFLO[®]

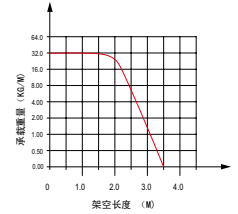
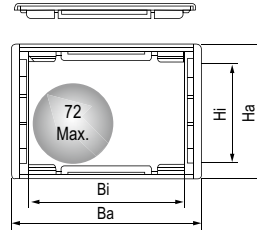
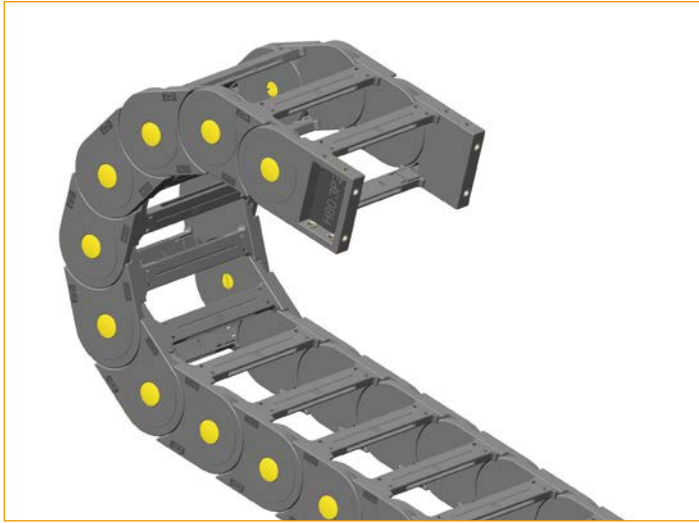

◎ 适用于直径 72 毫米以下线缆 Suitable for 72mm or less of cable.

主要技术参数 Basic technical data

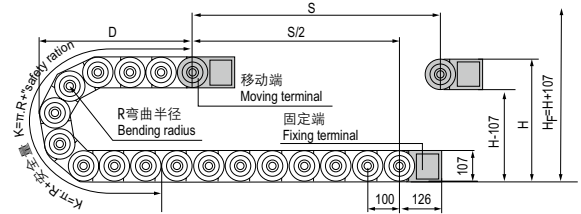

节距=100mm, 每米节数=10, 链长=S/2+K, S=行程距离, K=π.R+"安全量"+1 节距
Pitch=100mm, link per meter=10, length of chain=S/2+K, S=stroke. K=π.R+"safety ration"+1 Pitch

R	150	200	250	300	400	450	550	600
H	407	507	607	707	907	1007	1207	1307
D	304	354	404	454	554	604	704	754
K	700	900	1000	1200	1500	1700	2000	2100

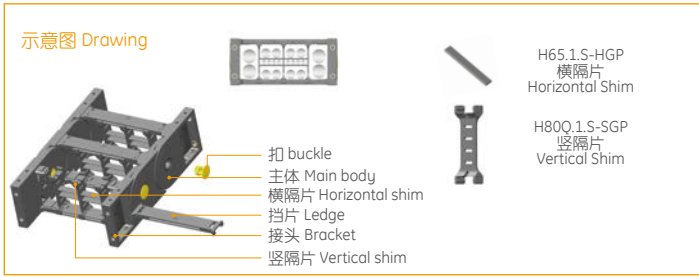

系列号 Series No.	内高 Hi	内宽 Bi	外高 Ha	外宽 Ba	款式 Styles	弯曲半径 Bending radius R	固定接头类型及参数 Bracket type and parameters						代号 No.		
							可配接头类型 Applicable bracket type	孔径 Bore diameter Φ1	孔距 (mm)hole distance						
H80Q.1.75S	80	75	107	123	Q.S	150,200,250, 300,400,450, 550,600,	F-Q	9	35	100	126	66	20	119	H80Q.1.75S-FJT
H80Q.1.100S	80	100	107	148	Q.S		F-Q	9	35	125	126	66	20	144	H80Q.1.100S-FJT
H80Q.1.125S	80	125	107	173	Q.S		F-Q	9	35	150	126	66	20	169	H80Q.1.125S-FJT
H80Q.1.150S	80	150	107	198	Q.S		F-Q	9	35	175	126	66	20	194	H80Q.1.150S-FJT
H80Q.1.175S	80	175	107	223	Q.S		F-Q	9	35	200	126	66	20	219	H80Q.1.175S-FJT
H80Q.1.200S	80	200	107	248	Q.S		F-Q	9	35	225	126	66	20	244	H80Q.1.200S-FJT
H80Q.1.250S	80	250	107	298	Q.S		F-Q	9	35	275	126	66	20	294	H80Q.1.250S-FJT
H80Q.1.300S	80	300	107	348	Q.S		F-Q	9	35	325	126	66	20	344	H80Q.1.300S-FJT
H80Q.1.350S	80	350	107	398	Q.S		F-Q	9	35	375	126	66	20	394	H80Q.1.350S-FJT

注: S 表示两侧可打开 Note: S indicates that the both side open

单位 (unit): mm

固定接头类型及参数 Fix bracket type and parameters (见表格 See table)



订货示例 Order Example

示例 拖链内高 80、内宽 75、半径 150、长度 1 米 /10 节 (Sample: inner height 80, inner width 75, radius 150, length 10 links/1 meter)

拖链 Chain H80Q.1.75S R150 1000mm /10 Links

接头 Bracket H80Q.1.75S-FJT 1 副 (Set)

配件 Accessories 每节装 1 个竖隔片 /1 个横隔片 (1 vertical shim/1 horizontal shim can be mounted in every link)

注: 可根据客户要求定制各种规格。 Note: Various sizes can be customized according to customer requirements.

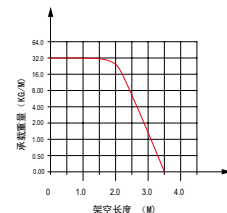
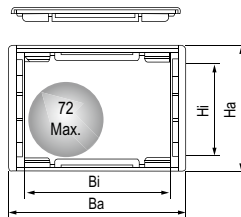
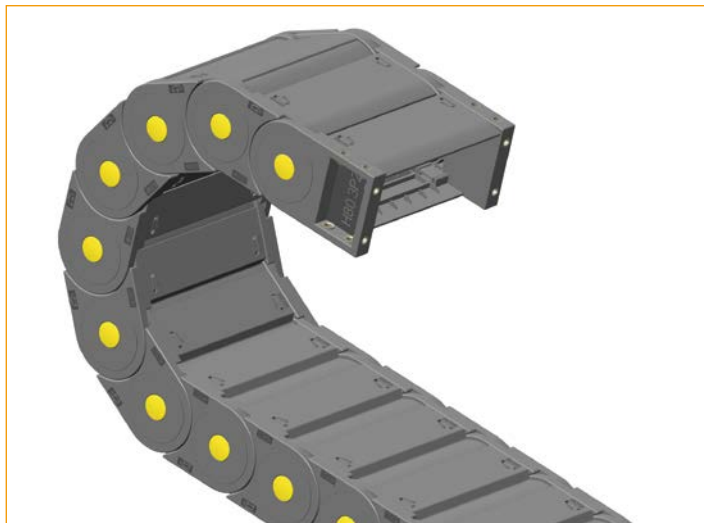

◎ 适用于直径 72 毫米以下线缆 Suitable for 72mm or less of cable.

主要技术参数 Basic technical data

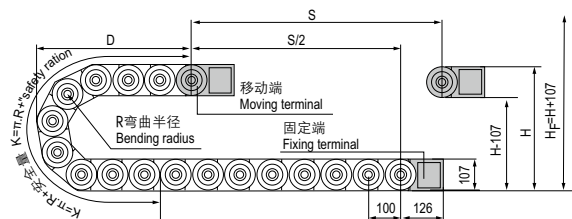

节距=100mm, 每米节数=10, 链长=S/2+K, S=行程距离, K=π·R+“安全量”+1 节距
Pitch=100mm, link per meter=10, length of chain=S/2+K, S=stroke, K=π·R+“safety ration”+1 Pitch

R	150	200	250	300	400	450	550	600
H	407	507	607	707	907	1007	1207	1307
D	304	354	404	454	554	604	704	754
K	700	900	1000	1200	1500	1700	2000	2100

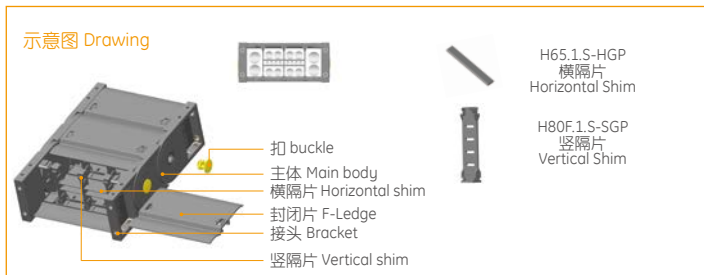

系列号 Series No.	内高 Hi	内宽 Bi	外高 Ha	外宽 Ba	款式 Styles	弯曲半径 Bending radius R	固定接头类型及参数 Bracket type and parameters						代号 No.		
							可配接头类型 Applicable bracket type	孔径 Bore diameter Φ1	孔距 (mm) hole distance						
H80F.1.100S	80	100	107	148	F.S	150,200,250, 300,400,450, 550,600,	F-F	9	35	125	126	66	20	144	H80F.1.100S-FJT
H80F.1.125S	80	125	107	173	F.S		F-F	9	35	150	126	66	20	169	H80F.1.125S-FJT
H80F.1.150S	80	150	107	198	F.S		F-F	9	35	175	126	66	20	194	H80F.1.150S-FJT
H80F.1.200S	80	200	107	248	F.S		F-F	9	35	225	126	66	20	244	H80F.1.200S-FJT
H80F.1.250S	80	250	107	298	F.S		F-F	9	35	275	126	66	20	294	H80F.1.250S-FJT
H80F.1.300S	80	300	107	348	F.S		F-F	9	35	325	126	66	20	344	H80F.1.300S-FJT
H80F.1.350S	80	350	107	398	F.S		F-F	9	35	375	126	66	20	394	H80F.1.350S-FJT

单位 (unit): mm

注: S 表示两侧可打开 Note: S indicates that the both side open

固定接头类型及参数 Fix bracket type and parameters (见表格 See table)

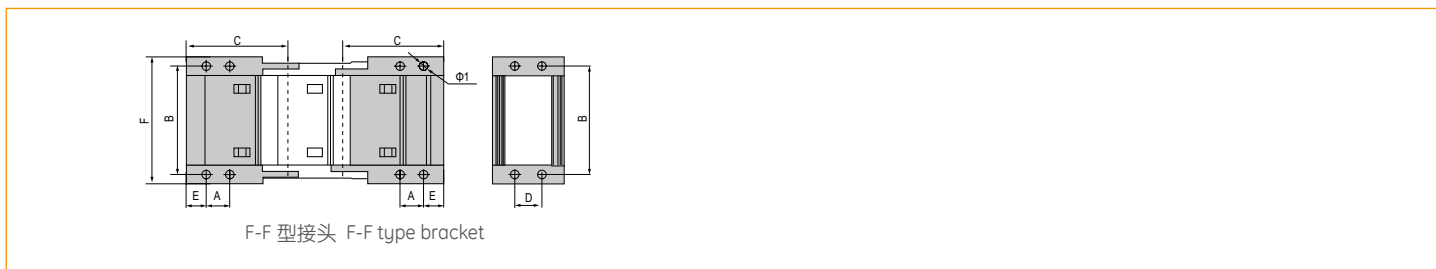

订货示例 Order Example

示例 拖链内高 80、内宽 150、半径 150、长度 1 米 /10 节 (Sample: inner height 80, inner width 150, radius 150, length 10 links/1 meter)

拖链 Chain H80F.1.150S R150 1000mm /10 Links

接头 Bracket H80F.1.150S-FJT 1 副 (Set)

配件 Accessories 每节装 1 个竖隔片 /1 个横隔片 (1 vertical shim/1 horizontal shim can be mounted in every link)

注: 可根据客户要求定制各种规格。 Note: Various sizes can be customized according to customer requirements.

HT35Q/F.1.S 系列 - 两侧可打开

Series of HT35Q/F.1.S-open of both side

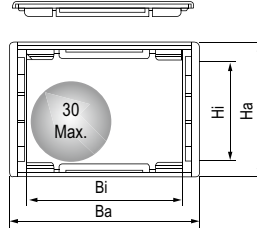
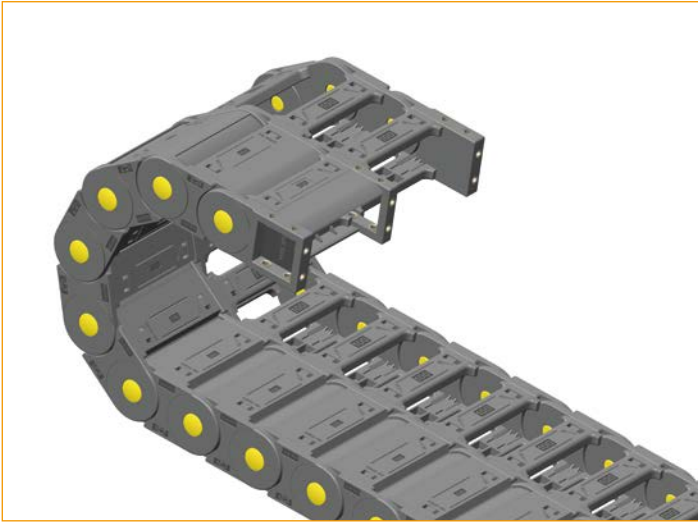

主要技术参数 Basic technical data

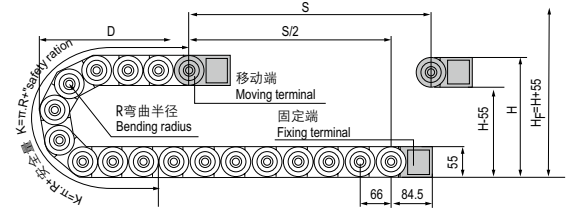

节距=66mm, 每米节数=15, ; 链长 =S/2+K, S=行程距离, K=π.R+"安全量"+1 节距
Pitch=66mm,link per meter=15,length of chain=S/2+K,S=stroke.K=π.R+"safety ration"+1 Pitch

R	75	100	125	150	200	300
H	205	255	305	355	455	655
D	169	194	219	244	294	394
K	396	462	528	660	792	1122

示意图 Drawing

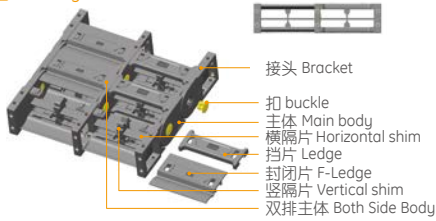

尺寸图 Dimension drawing

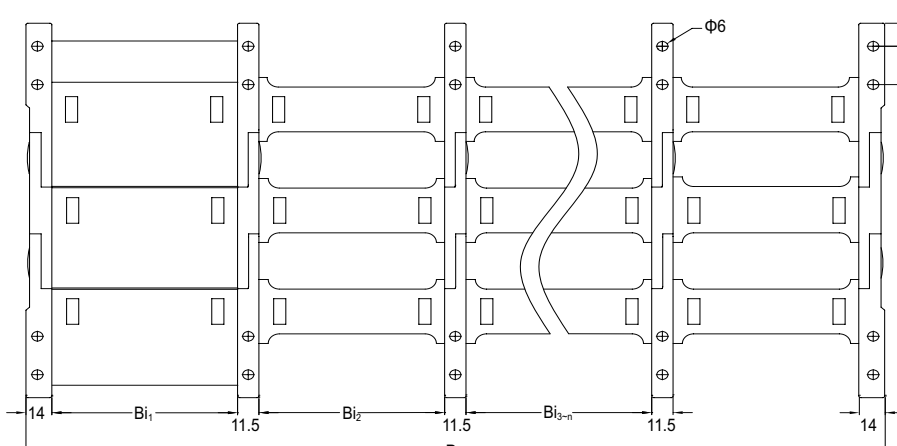
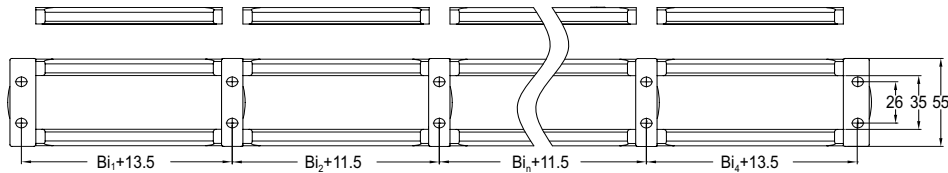

系列号 Series No.	内高 Hi	内宽 Bi		外高 Ha	外宽 Ba	弯曲半径 Bending radius R
		挡片 Ledge	封闭片 F-Ledge			
HT35Q(F).1.S	35	50 60 75 90 100 117 125 130 150 154 175 200 250 300	50 60 75 100 125 130 150	55	Ba = 28+ (Bi 1+Bi 2+Bi 3+...+Bi n) + (n-1)*11.5	75 100 125 150 200 300

注：桥式拖链与封闭式拖链可混合安装分隔片参照附录一

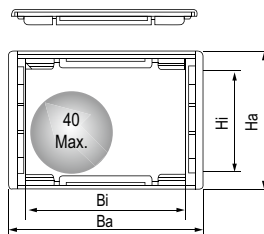
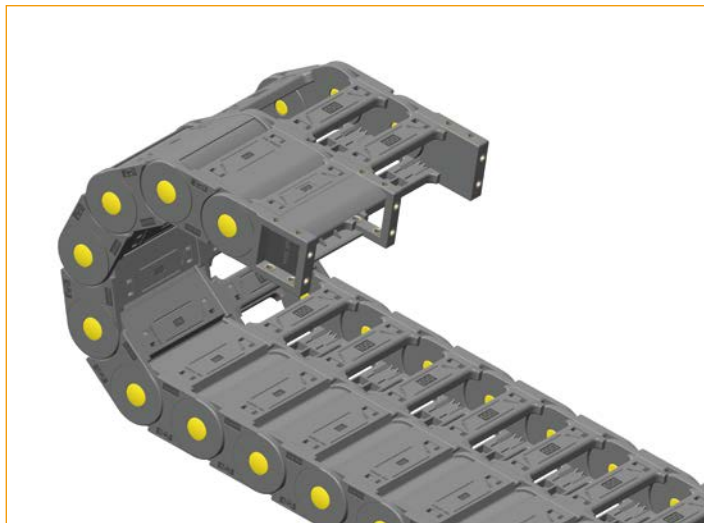

主要技术参数 Basic technical data

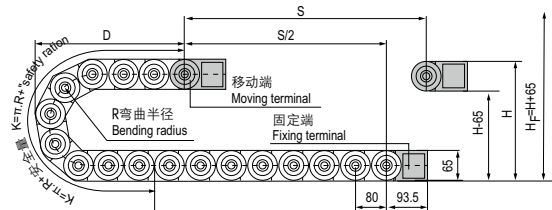

节距 =91mm, 每米节数 =11, ; 链长 =S/2+K, S=行程距离, K=π.R+"安全量"+1 节距
Pitch=91mm, link per meter=11, length of chain=S/2+K, S=stroke, K=π.R+"safety ration"+1 Pitch

R	75	100	125	150	200	250	300
H	215	265	315	365	465	565	665
D	188	213	238	263	313	363	413
K	400	480	560	640	800	960	1120

示意图 Drawing

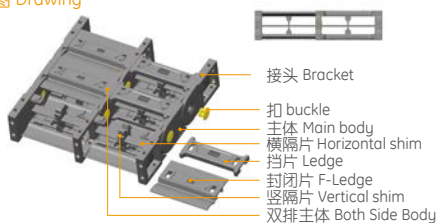

尺寸图 Dimension drawing

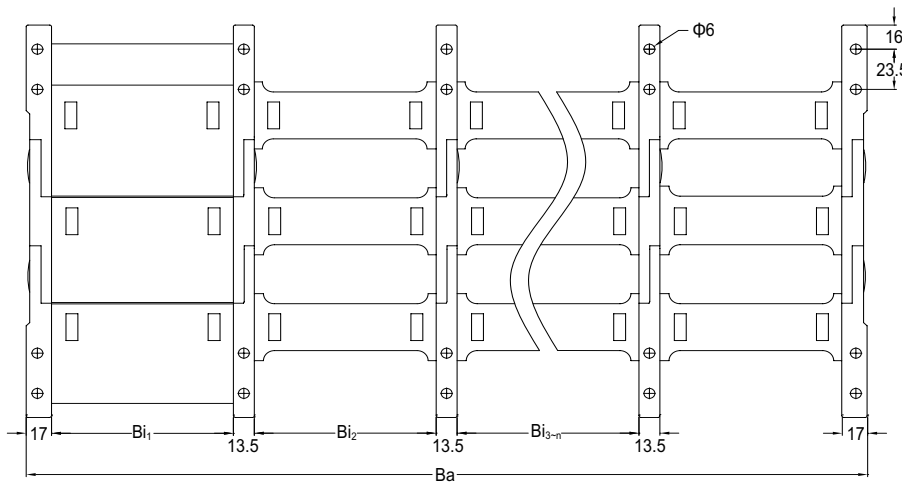
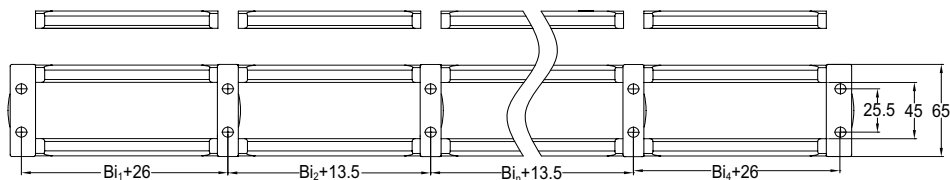

系列号 Series No.	内高 Hi	内宽 Bi				外高 Ha	外宽 Ba	弯曲半径 Bending radius R
		挡片 Ledge		封闭片 F-Ledge				
HT45Q(F).1.S	45	50 60 75 90 100 117 125 130	150 154 175 200 250 300	60 75 90 100 125	130 150 175 200	65	Ba = 34+ (Bi 1+Bi 2+Bi 3+...+Bi n) + (n-1)*13.5	75 100 125 150 200 250 300

注：桥式拖链与封闭式拖链可混合安装分隔片参照附录一

HT80Q/F.1.S 系列 - 两侧可打开

Series of HT80Q/F.1.S-open of both side

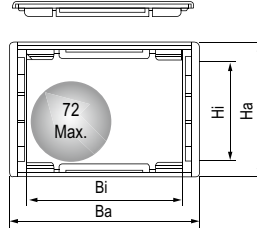
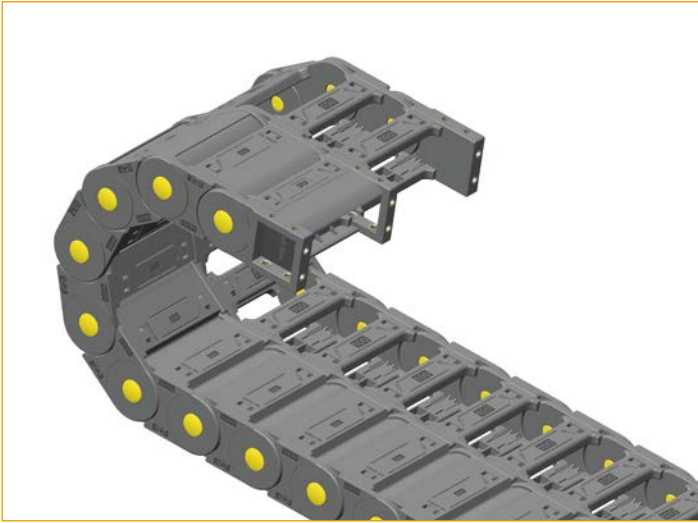

主要技术参数 Basic technical data

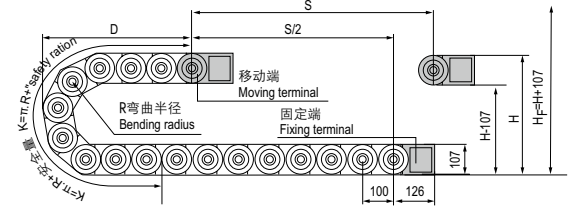

节距 =91mm, 每米节数 =11, ; 链长 =S/2+K, S=行程距离, $K = \pi \cdot R + "$ 安全量"+1 节距
Pitch=91mm, link per meter=11, length of chain=S/2+K, S=stroke, $K = \pi \cdot R + "$ safety ration"+1 Pitch

	R	150	200	250	300	400	450	550	600
H	407	507	607	707	907	1007	1207	1307	
D	304	354	404	454	554	604	704	754	
K	700	900	1000	1200	1500	1700	2000	2100	

示意图 Drawing

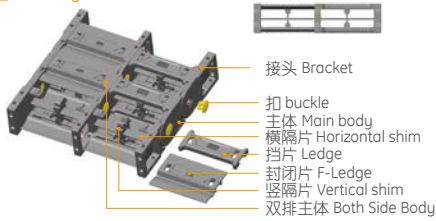

尺寸图 Dimension drawing

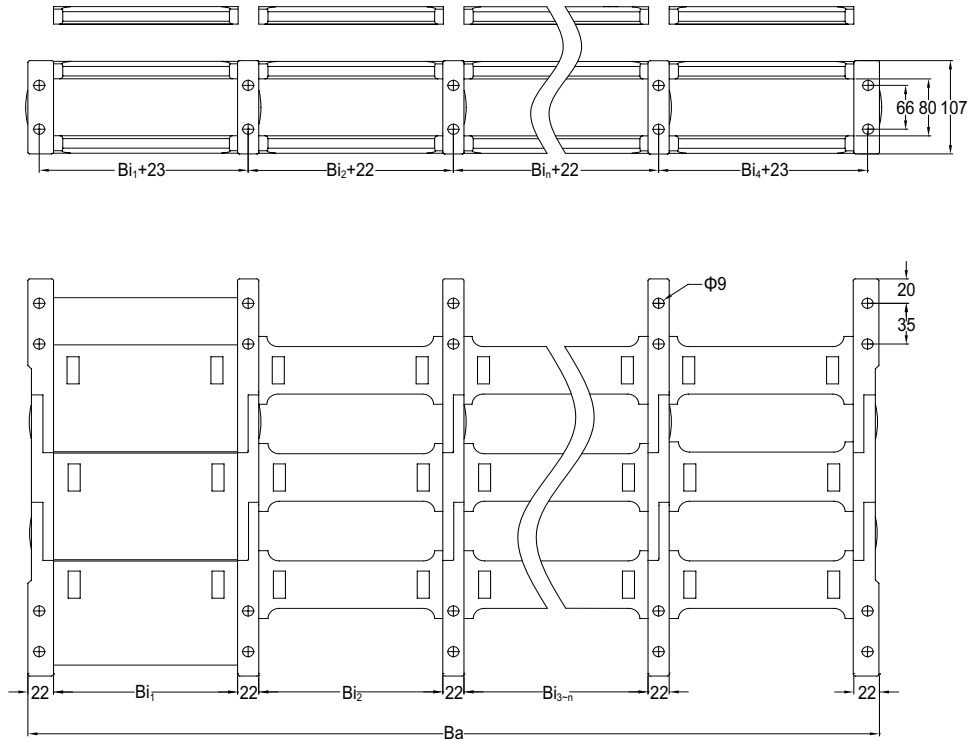

系列号 Series No.	内高 Hi	内宽 Bi		外高 Ha	外宽 Ba	弯曲半径 Bending radius R
		挡片 Ledge	封闭片 F-Ledge			
HT80Q(F).1.S	80	75 100 125 150 175 200 250 300 350	150 200 250 300 350	107	$Ba = 44 + (Bi_1 + Bi_2 + Bi_3 + \dots + Bi_n) + (n-1) * 22$	150 200 250 300 400 450 550 600

注：桥式拖链与封闭式拖链可混合安装分隔片参照附录一

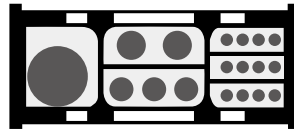

对应配套系列	竖隔片	横隔片
注: Bi 为拖链内宽 25 系列 Bi (25-125) 25 series		
30 系列 Bi (25-125) 30 series		
35 系列 Bi (25-125) 35 series		
45 系列 Bi (25-125) 45 series		
60 系列 Bi (25-125) 60 series		

可供选择的接头安装方式 Selectable connector mounting way

XJT-W 带孔移动端 (外部链节)
XJT-W moving terminal with the hole (external link)

FJT-W 带孔移动端 (外部链节)
FJT-W moving terminal with the hole (external link)

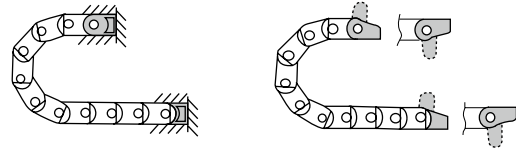
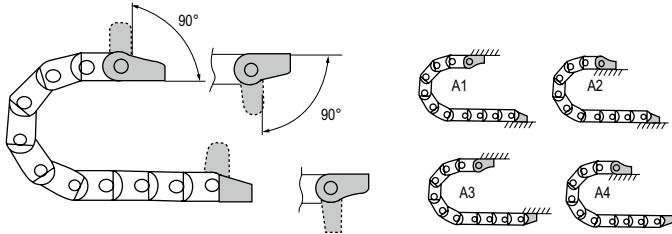

XJT-N 带销固定端 (内部链节)
XJT-N fixed terminal with pin (external link)

FJT-N 带销固定端 (内部链节)
FJT-N fixed terminal with pin (external link)

主要技术参数 Basic technical data

最大允许电缆外径 Max outer diameter of cable(mm)
最大水平悬空长度 Max horizontal hanging length(m)
最大允许行程 Max travel distance(m)
最大允许垂直悬挂 Max vertical hanging(m)

架空长度 Unsupported length

FLg= 直线架空长度
FLG=Linear unsupported length
FLb= 安全塌腰架空长度
FLb= Safety bending unsupported length

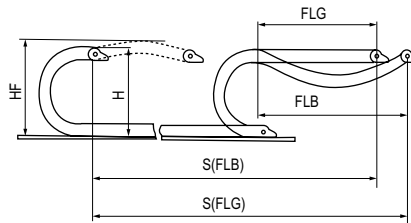

U 型接头可配附件 - 梳状板 U type applicable connector assessor-pectinate plate



抗冲击 Impact

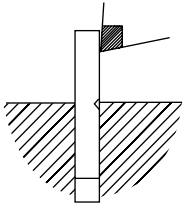

悬臂梁冲击
Cantilever beam impact

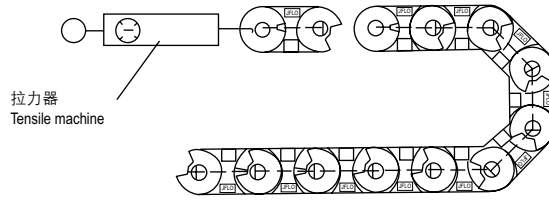

抗拉强度 Tensile strength

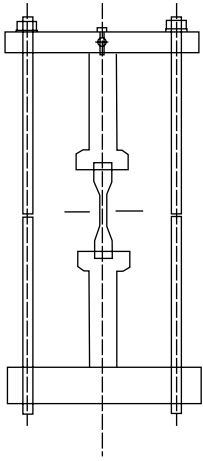

拱度 Arching degree

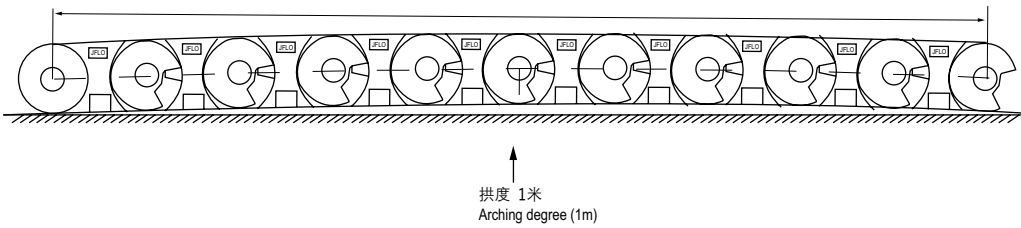

侧弯度 Lateral curvature degree

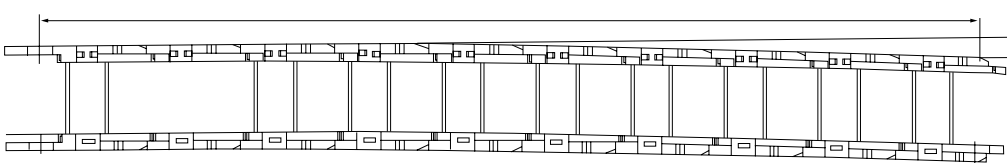

 采用生态纸印刷
Adopt ecological paper printing for this manual

© 金福隆机床附件有限公司版权所有
Jinfulong machine tool accessories all rights reserved

更多的产品型号与数据敬请期待中
More products and technical data will coming soon.

