

JEZ 系列 - 长距离载重拖链

JEZ Series - Heavy duty type cable chain



◎扣系列颜色可根据客户要求定制。

◎Buckle's color can be customized according to customer requirements.

测试使用寿命达 1 千万次以上
Its tested service life is up to 10 million times.

1

卡扣式链接方式，结构紧密牢固。
Snap-in connection, the structure is tight.

2

全新卡槽式链接，载重能力强。
New clamping slot type, load ability is strong.

3

可装竖隔片、横隔片区分空间，更有效保护线缆
The cable chain can be mounted separator and cross separator to effectively protect cables.

Contents 产品目录

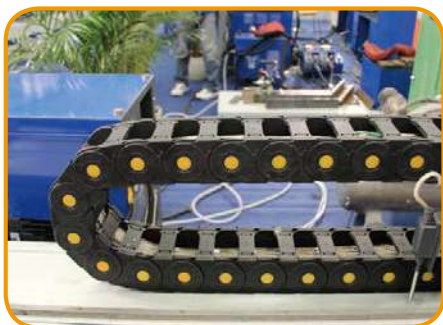

◎ JEZ 系列塑料拖链外形有不同的颜色可选择，更好的与应用产品的颜色相匹配，产品设计合理运行稳定。

◎ JEZ series cable chain: The series has different colors can be selected to match the color of the applied product. It make the product design more reasonably and work stably.

JEZ 系列拖链 JEZ Series

- 76 JEZ20Q.2.S 系列 - 桥式双侧打开
Series of JEZ20Q.2.S-Bridge type open of both side
- 77 JEZ20F.2.S 系列 - 全封闭式双侧打开
Series of JEZ20F.2.S-Enclosed open of both side
- 78 JEZ25Q.2.S 系列 - 桥式双侧打开
Series of JEZ25Q.2.S-Bridge type open of both side
- 79 JEZ25F.2.S 系列 - 全封闭式双侧打开
Series of JEZ25F.2.S-Enclosed open of both side
- 80 JEZ30Q.2.S 系列 - 桥式双侧打开
Series of JEZ30Q.2.S-Bridge type open of both side
- 81 JEZ30F.2.S 系列 - 全封闭式双侧打开
Series of JEZ30F.2.S-Enclosed open of both side
- 82 JEZ35Q.2.S 系列 - 桥式双侧打开
Series of JEZ35Q.2.S-Bridge type open of both side
- 83 JEZ35F.2.S 系列 - 全封闭式双侧打开
Series of JEZ35F.2.S-Enclosed open of both side
- 84 JEZ45Q.2.S 系列 - 桥式双侧打开
Series of JEZ45Q.2.S-Bridge type open of both side
- 85 JEZ45F.2.S 系列 - 全封闭式双侧打开
Series of JEZ45F.2.S-Enclosed open of both side
- 86 JEZ55Q.2.S 系列 - 桥式双侧打开
Series of JEZ55Q.2.S-Bridge type open of both side
- 87 JEZ55F.2.S 系列 - 全封闭式双侧打开
Series of JEZ55F.2.S-Enclosed open of both side
- 88 JEZ65Q.2.S 系列 - 桥式双侧打开
Series of JEZ65Q.2.S-Bridge type open of both side
- 89 JEZ65F.2.S 系列 - 全封闭式双侧打开
Series of JEZ65F.2.S-Enclosed open of both side
- 90 JEZ80Q.2.S 系列 - 桥式双侧打开
Series of JEZ80Q.2.S-Bridge type open of both side
- 91 JEZ80F.2.S 系列 - 全封闭式双侧打开
Series of JEZ80F.2.S-Enclosed open of both side
- 92 导向槽
The guide groove

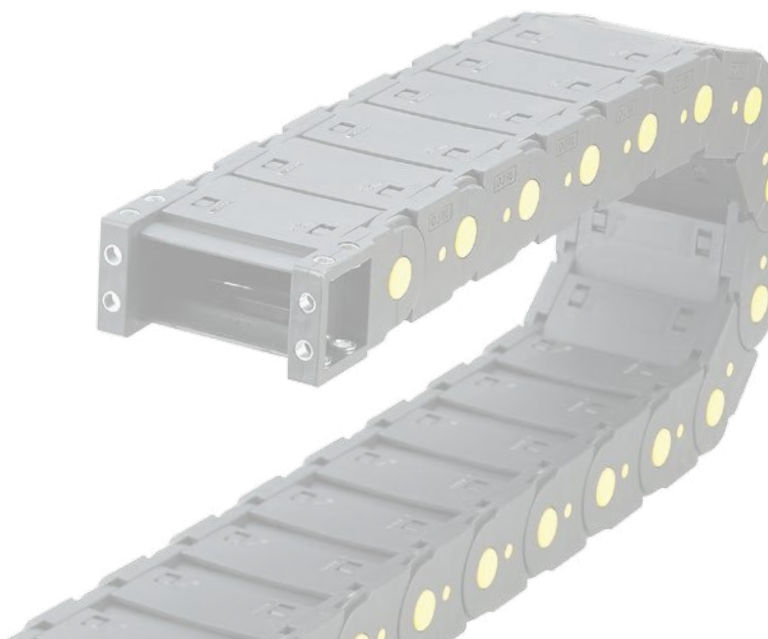

JEZ20Q.2.S 系列 - 桥式双侧打开

Series of JEZ20Q.2.S-Bridge type open of both side

JFLO[®]

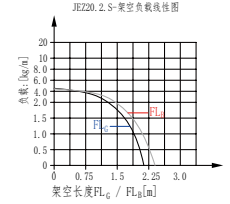
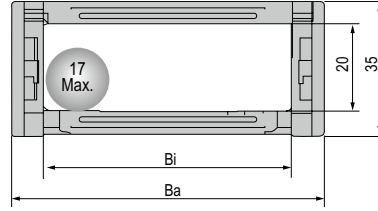

◎ 适用于直径 17 毫米以下线缆 Suitable for 17mm or less of cable.

主要技术参数 Basic technical data

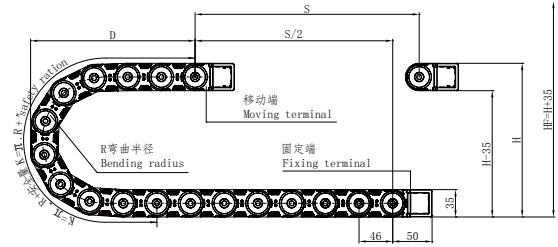

节距=46mm, 每米节数=22, 链长=S/2+K, S=行程距离, K=π·R+“安全量”
Pitch=46mm, link per meter=22, length of chain=S/2+K, S=stroke. K=π·R+“safety ration”

R	55	75	100	125
H	145	185	235	285
D	119	139	164	189
K	276	368	414	506

安装实际高度:H_F=H+35mm(负载 2kg/m)

Actual mounting height:H_F=H+35mm(load 2kg/m)

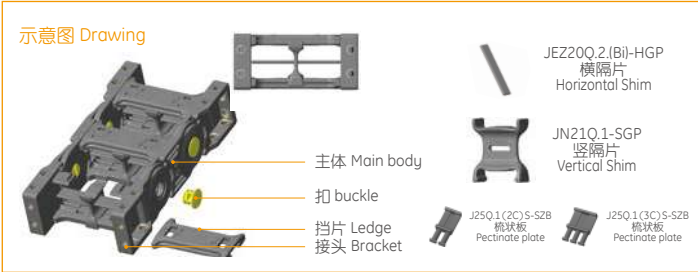

拖链型号 Cable Chain No.	内高 Hi	内宽 Bi	外高 Ha	外宽 Ba	款式 Styles	弯曲半径 Bending radius R	固定接头类型及参数 Bracket type and parameters								
							可配接头类型 Applicable bracket type	孔径 Bore diameter Φ1	孔距 (mm)hole distance					接头代号 Bracket No.	
JEZ20Q.2.25S	20	25	35	32	Q.S	55.75. 100.125	F-Q	4.5	15	38	50	15	8.5	47.5	JEZ20Q.2.25S-FJT
JEZ20Q.2.38S	20	38	35	55	Q.S		F-Q	4.5	15	51	50	15	8.5	60.5	JEZ20Q.2.38S-FJT
JEZ20Q.2.50S	20	50	35	67	Q.S		F-Q	4.5	15	63	50	15	8.5	72.5	JEZ20Q.2.50S-FJT
JEZ20Q.2.57S	20	57	35	74	Q.S		F-Q	4.5	15	70	50	15	8.5	79.5	JEZ20Q.2.57S-FJT
JEZ20Q.2.60S	20	60	35	77	Q.S		F-Q	4.5	15	73	50	15	8.5	82.5	JEZ20Q.2.60S-FJT
JEZ20Q.2.75S	20	75	35	92	Q.S		F-Q	4.5	15	88	50	15	8.5	97.5	JEZ20Q.2.75S-FJT
JEZ20Q.2.77S	20	77	35	94	Q.S		F-Q	4.5	15	90	50	15	8.5	99.5	JEZ20Q.2.77S-FJT
JEZ20Q.2.100S	20	100	35	117	Q.S		F-Q	4.5	15	113	50	15	8.5	122.5	JEZ20Q.2.100S-FJT
JEZ20Q.2.103S	20	103	35	120	Q.S		F-Q	4.5	15	116	50	15	8.5	125.5	JEZ20Q.2.103S-FJT
JEZ20Q.2.125S	20	125	35	142	Q.S		F-Q	4.5	15	138	50	15	8.5	147.5	JEZ20Q.2.125S-FJT

单位 (unit): mm

注: Q.S 表示桥式两侧可打开, F-Q 表示: 桥式方型接头, 不同序号表示安装孔的不同排列样式

Note: Q.S Bridge type open of both side, F-Q: bridge type square bracket, Different serial number indicates the difference rank type of fixing holes

固定接头类型及参数 Fix bracket type and parameters (见表格 See table)

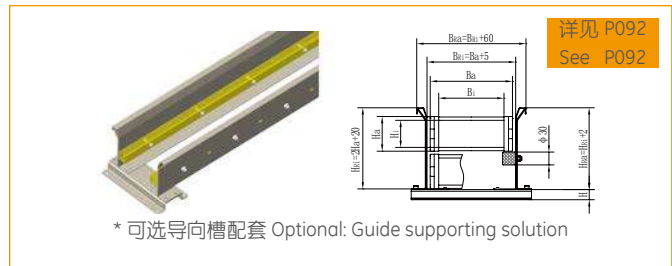
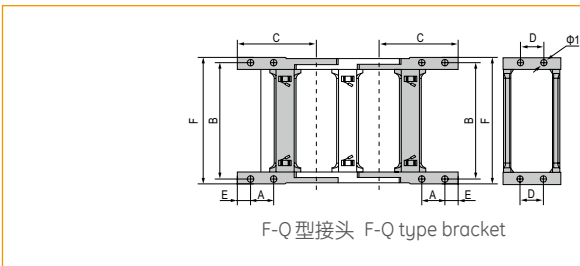

订货示例 Order Example

示例 拖链内高 20mm、内宽 25mm、半径 55mm、长度 1 米 /22 节 (Sample: inner height 20mm, inner width 25mm, radius 55mm, length 22 links/1 meter)

拖链 Chain JEZ20Q.2.25S R55 1000mm /22 Links (实际长度 Physical length: ± 2mm)

接头 Bracket JEZ20Q.2.25S-FJT 1 副 (Set)

配件 Accessories 每节装 1 个竖隔片 / 1 个横隔片 (1 vertical shim/1 horizontal shim can be mounted in every link)

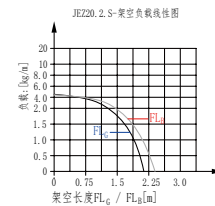
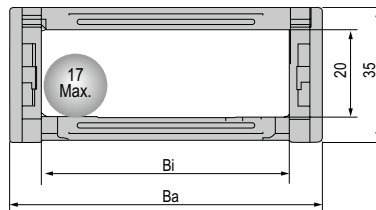

◎ 适用于直径 17 毫米以下线缆 Suitable for 17mm or less of cable.

主要技术参数 Basic technical data

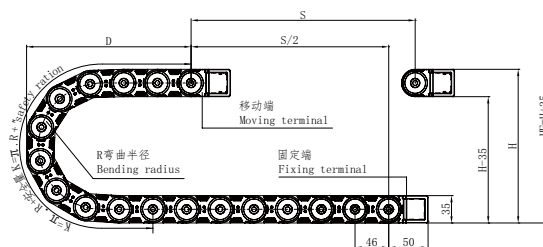

节距 = 46mm, 每米节数 = 22, 链长 = S/2 + K, S = 行程距离, K = π · R + "安全量"
Pitch = 46mm, link per meter = 22, length of chain = S/2 + K, S = stroke. K = π · R + "safety ration"

R	75	100	125
H	185	235	285
D	139	164	189
K	368	414	506

安装实际高度 :H_F = H + 35mm (负载 2kg/m)

Actual mounting height: H_F = H + 35mm (load 2kg/m)

示意图 Drawing

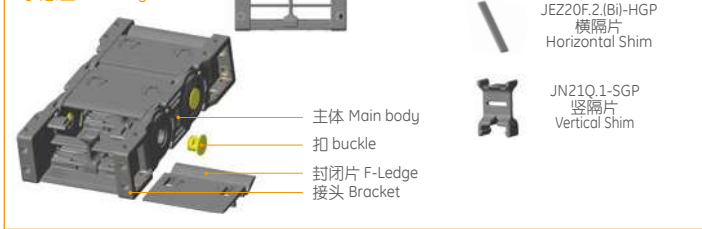

拖链型号 Cable Chain No.	内高 Hi	内宽 Bi	外高 Ha	外宽 Ba	款式 Styles	弯曲半径 Bending radius R	固定接头类型及参数 Bracket type and parameters								
							可配接头类型 Applicable bracket type	孔径 Bore diameter Φ1	孔距 (mm) hole distance						接头代号 Bracket No.
									A	B	C	D	E	F	
JEZ20F.2.38S	20	38	35	55	F.S	75.100.125	F-F	4.5	15	51	50	15	8.5	60.5	JEZ20F.2.38S-FJT
JEZ20F.2.50S	20	50	35	67	F.S		F-F	4.5	15	63	50	15	8.5	72.5	JEZ20F.2.50S-FJT
JEZ20F.2.57S	20	57	35	74	F.S		F-F	4.5	15	70	50	15	8.5	79.5	JEZ20F.2.57S-FJT
JEZ20F.2.60S	20	60	35	77	F.S		F-F	4.5	15	73	50	15	8.5	82.5	JEZ20F.2.60S-FJT
JEZ20F.2.75S	20	75	35	92	F.S		F-F	4.5	15	88	50	15	8.5	97.5	JEZ20F.2.75S-FJT
JEZ20F.2.100S	20	100	35	117	F.S		F-F	4.5	15	113	50	15	8.5	122.5	JEZ20F.2.100S-FJT

单位 (unit): mm

注: F.S 表示全封闭式双侧打开, F-F 表示: 封闭方型接头, 不同序号表示安装孔的不同排列样式

Note: F.S Enclosed open of both side, F-F: enclosed type bracket, Different serial number indicates the difference rank type of fixing holes

固定接头类型及参数 Fix bracket type and parameters (见表格 See table)

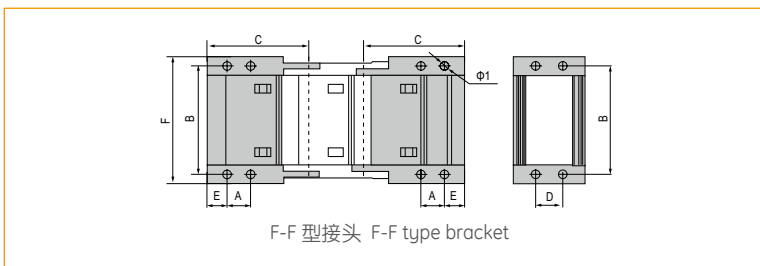

F-F 型接头 F-F type bracket

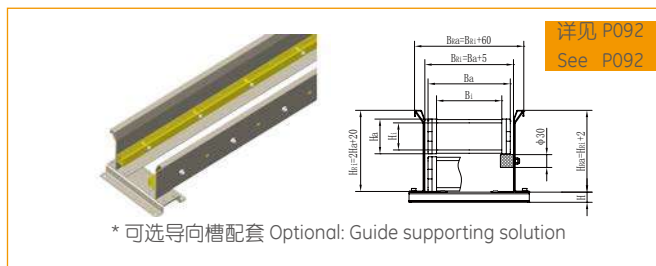

* 可选导向槽配套 Optional: Guide supporting solution

详见 P092
See P092

订货示例 Order Example

示例 拖链内高 20mm、内宽 38mm、半径 75mm、长度 1 米 / 22 节 (Sample: inner height 20mm, inner width 38mm, radius 75mm, length 22 links/1 meter)

拖链 Chain JEZ20F.2.38S R75 1000mm / 22 Links (实际长度 Physical length: ± 2mm)

接头 Bracket JEZ20F.2.38S-FJT 1 副 (Set)

配件 Accessories 每节装 1 个竖隔片 / 1 个横隔片 (1 vertical shim/1 horizontal shim can be mounted in every link)

JEZ25Q.2.S 系列 - 桥式双侧打开

Series of JEZ25Q.2.S-Bridge type open of both side

JFLO[®]

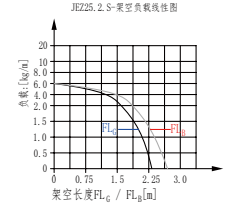
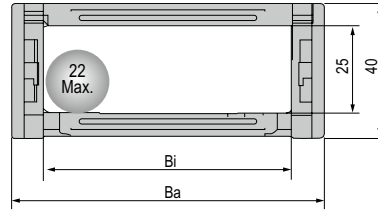

◎ 适用于直径 22 毫米以下线缆 Suitable for 22mm or less of cable.

主要技术参数 Basic technical data

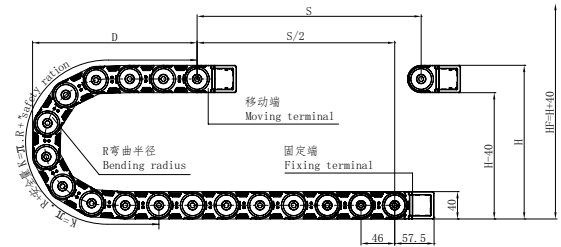

节距 = 46mm, 每米节数 = 22, 链长 = S/2 + K, S = 行程距离, K = π · R + "安全量"
Pitch = 46mm, link per meter = 22, length of chain = S/2 + K, S = stroke, K = π · R + "safety ration"

R	55	75	100	125	150
H	150	190	240	290	340
D	121	141	166	191	216
K	276	368	414	506	598

安装实际高度 :H_F=H+40mm(负载 3kg/m)

Actual mounting height:H_F=H+40mm(load 3kg/m)

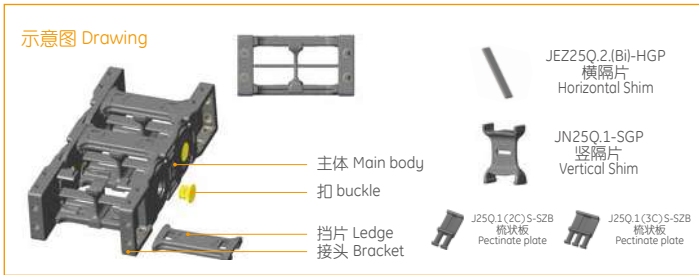

拖链型号 Cable Chain No.	内高 Hi	内宽 Bi	外高 Ha	外宽 Ba	款式 Styles	弯曲半径 Bending radius R	固定接头类型及参数 Bracket type and parameters								
							可配接头类型 Applicable bracket type	孔径 Bore diameter Φ1	孔距 (mm)hole distance					接头代号 Bracket No.	
JEZ25Q.2.25S	25	25	40	43.2	Q.S	55.75. 100.125.150	F-Q	4.5	16	37	57.5	16	9.5	46.5	JEZ25Q.2.25S-FJT
JEZ25Q.2.38S	25	38	40	56.2	Q.S		F-Q	4.5	16	50	57.5	16	9.5	59.5	JEZ25Q.2.38S-FJT
JEZ25Q.2.50S	25	50	40	68.2	Q.S		F-Q	4.5	16	62	57.5	16	9.5	71.5	JEZ25Q.2.50S-FJT
JEZ25Q.2.57S	25	57	40	75.2	Q.S		F-Q	4.5	16	69	57.5	16	9.5	78.5	JEZ25Q.2.57S-FJT
JEZ25Q.2.60S	25	60	40	78.2	Q.S		F-Q	4.5	16	72	57.5	16	9.5	81.5	JEZ25Q.2.60S-FJT
JEZ25Q.2.75S	25	75	40	93.2	Q.S		F-Q	4.5	16	87	57.5	16	9.5	96.5	JEZ25Q.2.75S-FJT
JEZ25Q.2.77S	25	77	40	95.2	Q.S		F-Q	4.5	16	89	57.5	16	9.5	98.5	JEZ25Q.2.77S-FJT
JEZ25Q.2.100S	25	100	40	118.2	Q.S		F-Q	4.5	16	112	57.5	16	9.5	121.5	JEZ25Q.2.100S-FJT
JEZ25Q.2.103S	25	103	40	121.2	Q.S		F-Q	4.5	16	115	57.5	16	9.5	124.5	JEZ25Q.2.103S-FJT
JEZ25Q.2.125S	25	125	40	143.2	Q.S		F-Q	4.5	16	137	57.5	16	9.5	146.5	JEZ25Q.2.125S-FJT

单位 (unit): mm

注: Q.S 表示桥式两侧可打开, F-Q 表示: 桥式方型接头, 不同序号表示安装孔的不同排列样式

Note: Q.S Bridge type open of both side, F-Q: bridge type square bracket, Different serial number indicates the difference rank type of fixing holes

固定接头类型及参数 Fix bracket type and parameters (见表格 See table)

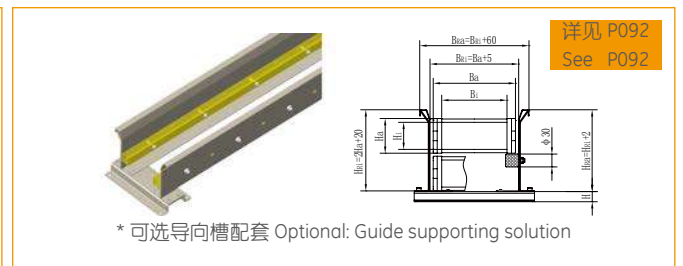
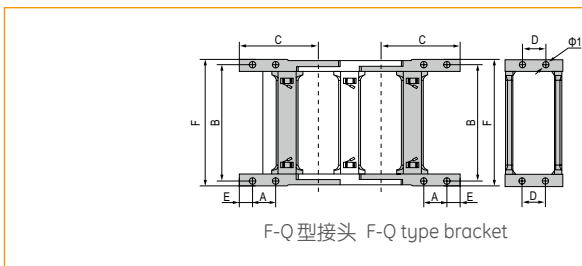

订货示例 Order Example

示例 拖链内高 25mm、内宽 25mm、半径 55mm、长度 1 米 /22 节 (Sample: inner height 25mm, inner width 25mm, radius 55mm, length 22 links/1 meter)

拖链 Chain JEZ25Q.2.25S R55 1000mm /22 Links (实际长度 Physical length: ± 2mm)

接头 Bracket JEZ25Q.2.25S-FJT 1 副 (Set)

配件 Accessories 每节装 1 个竖隔片 / 1 个横隔片 (1 vertical shim/1 horizontal shim can be mounted in every link)

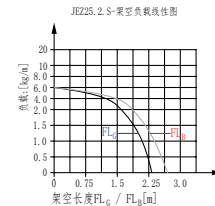
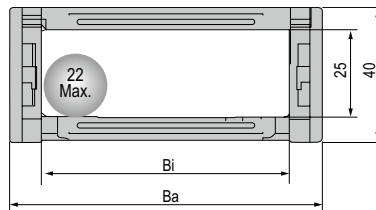

◎ 适用于直径 22 毫米以下线缆 Suitable for 22mm or less of cable.

主要技术参数 Basic technical data

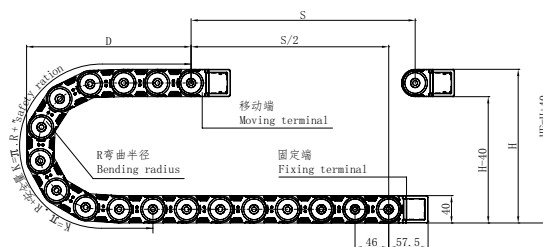

节距 = 46mm, 每米节数 = 22, 链长 = S/2 + K, S = 行程距离, K = π · R + "安全量"
Pitch = 46mm, link per meter = 22, length of chain = S/2 + K, S = stroke, K = π · R + "safety ration"

R	75	100	125	150
H	190	240	290	340
D	141	166	191	216
K	368	414	506	598

安装实际高度 :H_f = H + 40mm (负载 3kg/m)

Actual mounting height:H_f = H + 40mm (load 3kg/m)

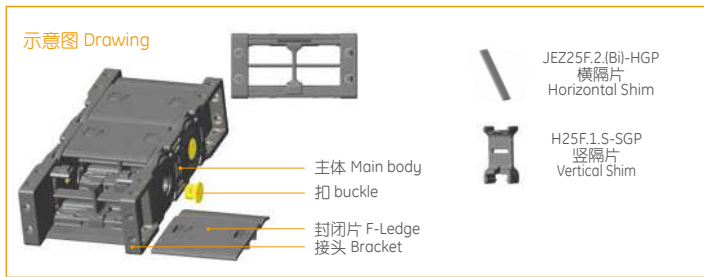

拖链型号 Cable Chain No.	内高 Hi	内宽 Bi	外高 Ha	外宽 Ba	款式 Styles	弯曲半径 Bending radius R	固定接头类型及参数 Bracket type and parameters								
							可配接头类型 Applicable bracket type	孔径 Bore diameter Φ1	孔距 (mm)hole distance						接头代号 Bracket No.
									A	B	C	D	E	F	
JEZ25F.2.38S	25	38	40	56.2	F.S	75.100. 125.150	F-F	4.5	16	50	57.5	16	9.5	59.5	JEZ25F.2.38S-FJT
JEZ25F.2.50S	25	50	40	68.2	F.S		F-F	4.5	16	62	57.5	16	9.5	71.5	JEZ25F.2.50S-FJT
JEZ25F.2.57S	25	57	40	75.2	F.S		F-F	4.5	16	69	57.5	16	9.5	78.5	JEZ25F.2.57S-FJT
JEZ25F.2.60S	25	60	40	78.2	F.S		F-F	4.5	16	72	57.5	16	9.5	81.5	JEZ25F.2.60S-FJT
JEZ25F.2.75S	25	75	40	93.2	F.S		F-F	4.5	16	87	57.5	16	9.5	96.5	JEZ25F.2.75S-FJT
JEZ25F.2.100S	25	100	40	118.2	F.S		F-F	4.5	16	112	57.5	16	9.5	121.5	JEZ25F.2.100S-FJT

单位 (unit): mm

注: F.S 表示全封闭式双侧打开, F-F 表示: 封闭方型接头, 不同序号表示安装孔的不同排列样式

Note: F.S Enclosed open of both side, F-F: enclosed type bracket, Different serial number indicates the difference rank type of fixing holes

固定接头类型及参数 Fix bracket type and parameters (见表格 See table)

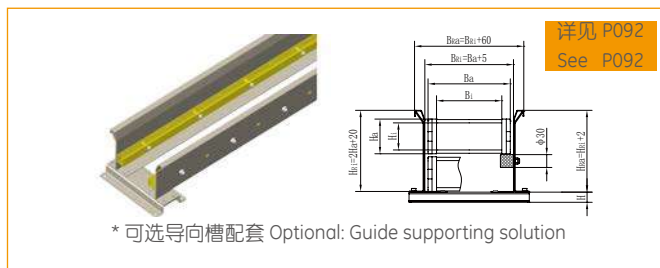
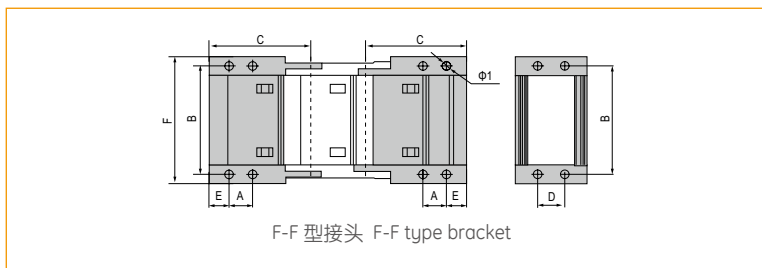

详见 P092
See P092

订货示例 Order Example

示例 拖链内高 25mm、内宽 38mm、半径 75mm、长度 1 米 / 22 节 (Sample: inner height 25mm, inner width 38mm, radius 75mm, length 1 meter / 22 links)

拖链 Chain JEZ25F.2.38S R75 1000mm / 22 Links (实际长度 Physical length: ± 2mm)

接头 Bracket JEZ25F.2.38S-FJT 1 副 (Set)

配件 Accessories 每节装 1 个竖隔片 / 1 个横隔片 (1 vertical shim / 1 horizontal shim can be mounted in every link)

JEZ30Q.2.S 系列 - 桥式双侧打开

Series of JEZ30Q.2.S-Bridge type open of both side

JFLO[®]

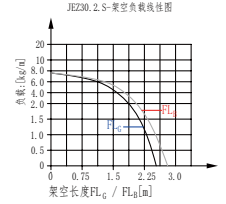
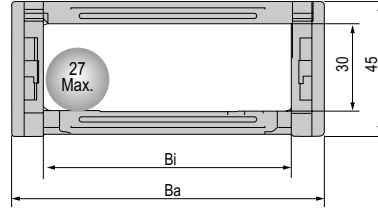

◎ 适用于直径 27 毫米以下线缆 Suitable for 27mm or less of cable.

主要技术参数 Basic technical data

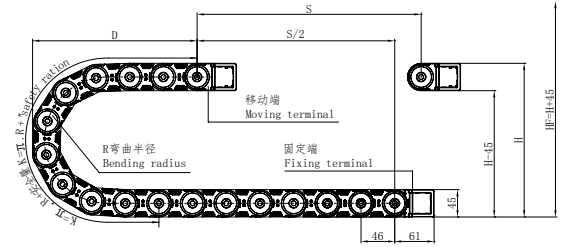

节距=46mm, 每米节数=22, 链长=S/2+K, S=行程距离, K=π.R+“安全量”
Pitch=46mm, link per meter=22, length of chain=S/2+K, S=stroke. K=π.R+“safety ration”

R	55	75	100	125	150
H	155	195	245	295	345
D	124	144	169	194	219
K	276	368	414	506	598

安装实际高度:H_F=H+45mm(负载 4kg/m)
Actual mounting height:H_F=H+45mm(load 4kg/m)

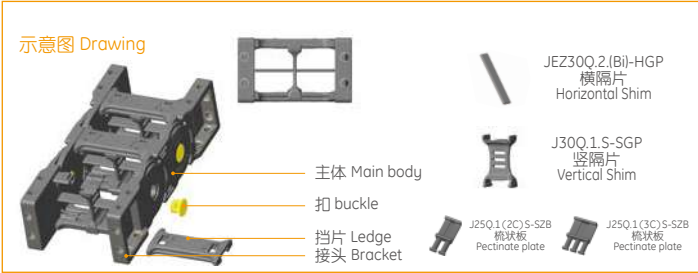

拖链型号 Cable Chain No.	内高 Hi	内宽 Bi	外高 Ha	外宽 Ba	款式 Styles	弯曲半径 Bending radius R	固定接头类型及参数 Bracket type and parameters						接头代号 Bracket No.		
							可配接头类型 Applicable bracket type	孔径 Bore diameter Φ1	孔距 (mm)hole distance						
JEZ30Q.2.25S	30	25	45	44.2	Q.S	55.75. 100.125.150	F-Q	5.5	18	39	61	18	11	49	JEZ30Q.2.25S-FJT
JEZ30Q.2.38S	30	38	45	57.2	Q.S		F-Q	5.5	18	52	61	18	11	62	JEZ30Q.2.38S-FJT
JEZ30Q.2.50S	30	50	45	69.2	Q.S		F-Q	5.5	18	64	61	18	11	74	JEZ30Q.2.50S-FJT
JEZ30Q.2.57S	30	57	45	76.2	Q.S		F-Q	5.5	18	71	61	18	11	81	JEZ30Q.2.57S-FJT
JEZ30Q.2.60S	30	60	45	79.2	Q.S		F-Q	5.5	18	74	61	18	11	84	JEZ30Q.2.60S-FJT
JEZ30Q.2.75S	30	75	45	94.2	Q.S		F-Q	5.5	18	89	61	18	11	99	JEZ30Q.2.75S-FJT
JEZ30Q.2.77S	30	77	45	96.2	Q.S		F-Q	5.5	18	91	61	18	11	101	JEZ30Q.2.77S-FJT
JEZ30Q.2.100S	30	100	45	119.2	Q.S		F-Q	5.5	18	114	61	18	11	124	JEZ30Q.2.100S-FJT
JEZ30Q.2.103S	30	103	45	122.2	Q.S		F-Q	5.5	18	117	61	18	11	127	JEZ30Q.2.103S-FJT
JEZ30Q.2.125S	30	125	45	144.2	Q.S		F-Q	5.5	18	139	61	18	11	149	JEZ30Q.2.125S-FJT

单位 (unit): mm

注: Q.S 表示桥式两侧可打开, F-Q 表示: 桥式方型接头, 不同序号表示安装孔的不同排列样式

Note: Q.S Bridge type open of both side, F-Q: bridge type square bracket, Different serial number indicates the difference rank type of fixing holes

固定接头类型及参数 Fix bracket type and parameters (见表格 See table)

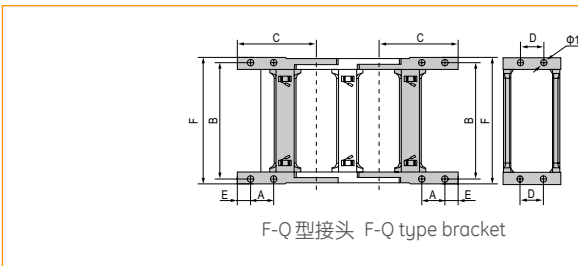

订货示例 Order Example

示例 拖链内高 30mm、内宽 25mm、半径 55mm、长度 1 米 /22 节 (Sample: inner height 30mm, inner width 25mm, radius 55mm, length 22 links/1 meter)

拖链 Chain JEZ30Q.2.25S R55 1000mm /22 Links (实际长度 Physical length: ± 2mm)

接头 Bracket JEZ30Q.2.25S-FJT 1 副 (Set)

配件 Accessories 每节装 1 个竖隔片 / 1 个横隔片 (1 vertical shim/1 horizontal shim can be mounted in every link)

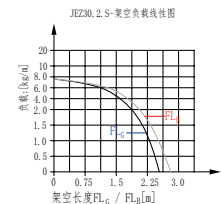
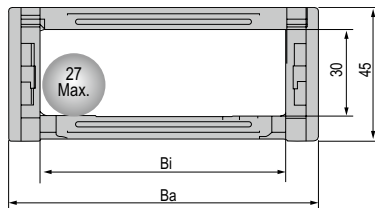

◎ 适用于直径 27 毫米以下线缆 Suitable for 27mm or less of cable.

主要技术参数 Basic technical data

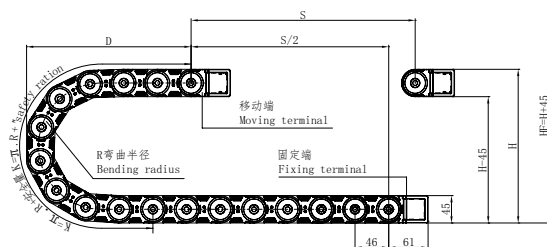

节距 = 46mm, 每米节数 = 22, 链长 = S/2 + K, S = 行程距离, K = π · R + "安全量"
Pitch = 46mm, link per meter = 22, length of chain = S/2 + K, S = stroke, K = π · R + "safety ration"

R	75	100	125	150
H	195	245	295	345
D	144	169	194	219
K	368	414	506	598

安装实际高度 : H_F = H + 45mm (负载 4kg/m)

Actual mounting height: H_F = H + 45mm (load 4kg/m)

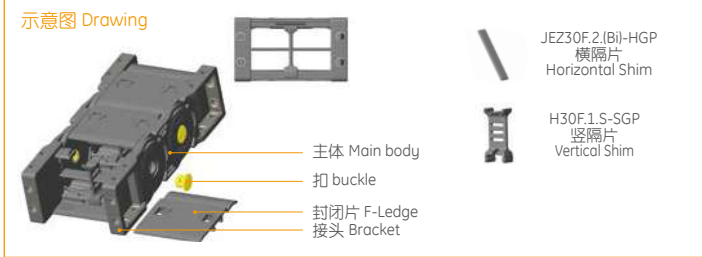

拖链型号 Cable Chain No.	内高 Hi	内宽 Bi	外高 Ha	外宽 Ba	款式 Styles	弯曲半径 Bending radius R	固定接头类型及参数 Bracket type and parameters								
							可配接头类型 Applicable bracket type	孔径 Bore diameter Φ1	孔距 (mm)hole distance					接头代号 Bracket No.	
JEZ30F.2.38S	30	38	45	57.2	F.S	75.100. 125.150	F-F	5.5	18	52	61	18	11	62	JEZ30F.2.38S-FJT
JEZ30F.2.50S	30	50	45	69.2	F.S		F-F	5.5	18	64	61	18	11	74	JEZ30F.2.50S-FJT
JEZ30F.2.57S	30	57	45	76.2	F.S		F-F	5.5	18	71	61	18	11	81	JEZ30F.2.57S-FJT
JEZ30F.2.60S	30	60	45	79.2	F.S		F-F	5.5	18	74	61	18	11	84	JEZ30F.2.60S-FJT
JEZ30F.2.75S	30	75	45	94.2	F.S		F-F	5.5	18	89	61	18	11	99	JEZ30F.2.75S-FJT
JEZ30F.2.100S	30	100	45	119.2	F.S		F-F	5.5	18	114	61	18	11	124	JEZ30F.2.100S-FJT

单位 (unit): mm

注: F.S 表示全封闭式双侧打开, F-F 表示: 封闭方型接头, 不同序号表示安装孔的不同排列样式

Note: F.S Enclosed open of both side, F-F: enclosed type bracket, Different serial number indicates the difference rank type of fixing holes

固定接头类型及参数 Fix bracket type and parameters (见表格 See table)

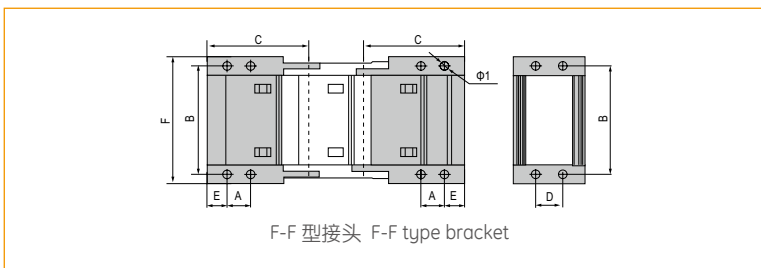

F-F 型接头 F-F type bracket

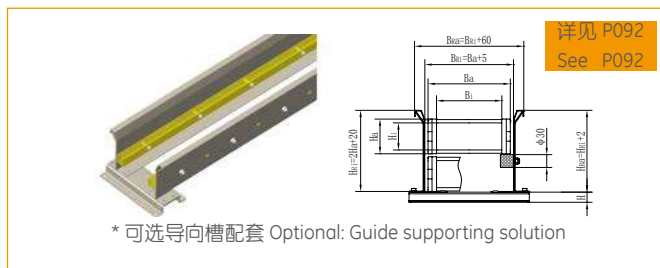

详见 P092
See P092

订货示例 Order Example

示例 拖链内高 30mm、内宽 38mm、半径 75mm、长度 1 米 / 22 节 (Sample: inner height 30mm, inner width 38mm, radius 75mm, length 22 links/1 meter)

拖链 Chain JEZ30F.2.38S R75 1000mm / 22 Links (实际长度 Physical length: ± 2mm)

接头 Bracket JEZ30F.2.38S-FJT 1 副 (Set)

配件 Accessories 每节装 1 个竖隔片 / 1 个横隔片 (1 vertical shim/1 horizontal shim can be mounted in every link)

JEZ35Q.2.S 系列 - 桥式双侧打开

Series of JEZ35Q.2.S-Bridge type open of both side

JFLO[®]

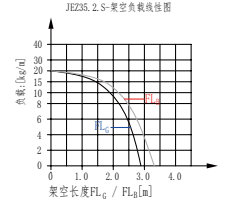
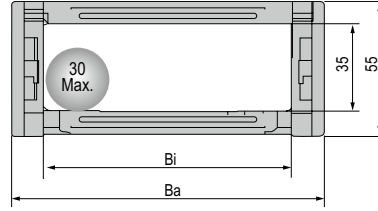

◎ 适用于直径 30 毫米以下线缆 Suitable for 30mm or less of cable.

主要技术参数 Basic technical data

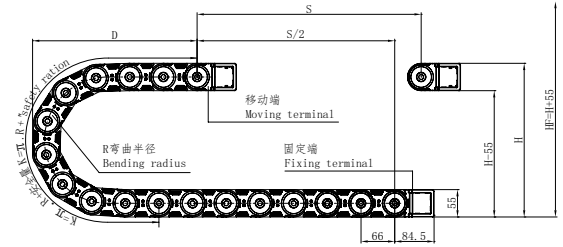

节距=66mm, 每米节数=15, 链长=S/2+K, S=行程距离, K=π·R+“安全量”
Pitch=66mm, link per meter=15, length of chain=S/2+K, S=stroke. K=π·R+“safety ration”

R	75	100	125	150	175	200	300
H	205	255	305	355	405	455	655
D	169	194	219	244	269	294	394
K	396	462	528	660	726	792	1122

安装实际高度 :H_f=H+55mm(负载 15kg/m)

Actual mounting height:H_f=H+55mm(load 15kg/m)

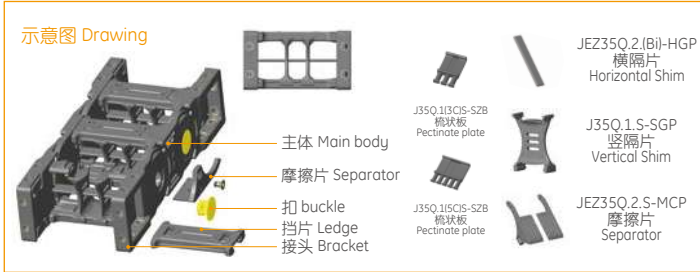

拖链型号 Cable Chain No.	内高 Hi	内宽 Bi	外高 Ha	外宽 Ba	款式 Styles	弯曲半径 Bending radius R	固定接头类型及参数 Bracket type and parameters								
							可配接头类型 Applicable bracket type	孔径 Bore diameter Φ1	孔距 (mm)hole distance						接头代号 Bracket No.
									A	B	C	D	E	F	
JEZ35Q.2.50S	35	50	55	73.2	Q.S	75.100.125. 150.175.200. 300	F-Q	6	24	66	84.5	26	16	78	JEZ35Q.2.50S-FJT
JEZ35Q.2.60S	35	60	55	83.2	Q.S		F-Q	6	24	76	84.5	26	16	88	JEZ35Q.2.60S-FJT
JEZ35Q.2.75S	35	75	55	98.2	Q.S		F-Q	6	24	91	84.5	26	16	103	JEZ35Q.2.75S-FJT
JEZ35Q.2.90S	35	90	55	113.2	Q.S		F-Q	6	24	106	84.5	26	16	118	JEZ35Q.2.90S-FJT
JEZ35Q.2.100S	35	100	55	123.2	Q.S		F-Q	6	24	116	84.5	26	16	128	JEZ35Q.2.100S-FJT
JEZ35Q.2.117S	35	117	55	140.2	Q.S		F-Q	6	24	133	84.5	26	16	145	JEZ35Q.2.117S-FJT
JEZ35Q.2.125S	35	125	55	148.2	Q.S		F-Q	6	24	141	84.5	26	16	153	JEZ35Q.2.125S-FJT
JEZ35Q.2.130S	35	130	55	153.2	Q.S		F-Q	6	24	146	84.5	26	16	158	JEZ35Q.2.130S-FJT
JEZ35Q.2.150S	35	150	55	173.2	Q.S		F-Q	6	24	166	84.5	26	16	178	JEZ35Q.2.150S-FJT
JEZ35Q.2.154S	35	154	55	177.2	Q.S		F-Q	6	24	170	84.5	26	16	182	JEZ35Q.2.154S-FJT
JEZ35Q.2.175S	35	175	55	198.2	Q.S		F-Q	6	24	191	84.5	26	16	203	JEZ35Q.2.175S-FJT
JEZ35Q.2.200S	35	200	55	223.2	Q.S		F-Q	6	24	216	84.5	26	16	228	JEZ35Q.2.200S-FJT
JEZ35Q.2.250S	35	250	55	273.2	Q.S		F-Q	6	24	266	84.5	26	16	278	JEZ35Q.2.250S-FJT
JEZ35Q.2.300S	35	300	55	323.2	Q.S		F-Q	6	24	316	84.5	26	16	328	JEZ35Q.2.300S-FJT

单位 (unit): mm

注: Q.S 表示桥式双侧可打开, F-Q 表示: 桥式方型接头, 不同序号表示安装孔的不同排列样式

Note: Q.S Bridge type open of both side, F-Q: bridge type square bracket, Different serial number indicates the difference rank type of fixing holes

固定接头类型及参数 Fix bracket type and parameters (见表格 See table)

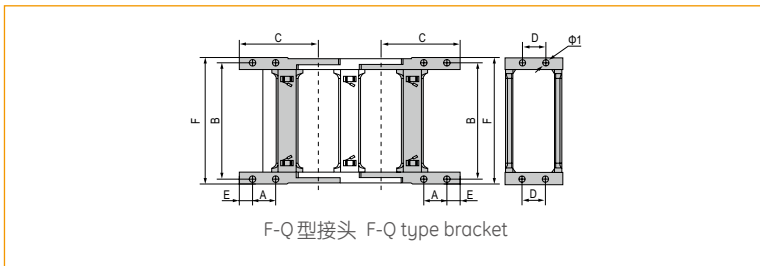

订货示例 Order Example

示例 拖链内高 35mm、内宽 50mm、半径 75mm、长度 1 米 /15 节 (Sample: inner height 35mm, inner width 50mm, radius 75mm, length 15 links/1 meter)

拖链 Chain JEZ35Q.2.50S R75 1000mm /15 Links (实际长度 Physical length: ± 2mm)

接头 Bracket JEZ35Q.2.50S-FJT 1 副 (Set)

配件 Accessories 每节装 1 个竖隔片 / 1 个横隔片 (1 vertical shim/1 horizontal shim can be mounted in every link)

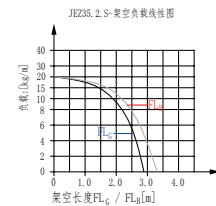
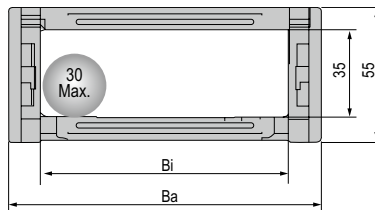

◎ 适用于直径 30 毫米以下线缆 Suitable for 30mm or less of cable.

主要技术参数 Basic technical data

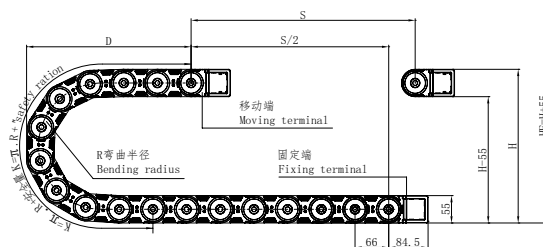

节距 = 66mm, 每米节数 = 15, 链长 = S/2 + K, S = 行程距离, K = π · R + "安全量"
Pitch = 66mm, link per meter = 15, length of chain = S/2 + K, S = stroke, K = π · R + "safety ration"

R	100	125	150	175	200	300
H	255	305	355	405	455	655
D	194	219	244	269	294	394
K	462	528	660	726	792	1122

安装实际高度 :H_f = H + 55mm (负载 15kg/m)

Actual mounting height: H_f = H + 55mm (load 15kg/m)

示意图 Drawing

- JEZ35F.2.(Bi)-HGP 横隔片 Horizontal Shim
- H35F.1.S-SGP 竖隔片 Vertical Shim
- JEZ35F.2.S-MCP 摩擦片 Separator
- 主体 Main body
- 摩擦片 Separator
- 扣 buckle
- 封闭片 F-Ledge
- 接头 Bracket

拖链型号 Cable Chain No.	内高 Hi	内宽 Bi	外高 Ha	外宽 Ba	款式 Styles	弯曲半径 Bending radius R	固定接头类型及参数 Bracket type and parameters								
							可配接头类型 Applicable bracket type	孔径 Bore diameter Φ1	孔距 (mm) hole distance					接头代号 Bracket No.	
									A	B	C	D	E		F
JEZ35F.2.50S	35	50	55	73.2	F.S	100.125. 150.175. 200.300	F-F	6	24	66	84.5	26	16	78	JEZ35F.2.50S-FJT
JEZ35F.2.60S	35	60	55	83.2	F.S		F-F	6	24	76	84.5	26	16	88	JEZ35F.2.60S-FJT
JEZ35F.2.75S	35	75	55	98.2	F.S		F-F	6	24	91	84.5	26	16	103	JEZ35F.2.75S-FJT
JEZ35F.2.100S	35	100	55	123.2	F.S		F-F	6	24	116	84.5	26	16	128	JEZ35F.2.100S-FJT
JEZ35F.2.125S	35	125	55	148.2	F.S		F-F	6	24	141	84.5	26	16	153	JEZ35F.2.125S-FJT
JEZ35F.2.130S	35	130	55	153.2	F.S		F-F	6	24	146	84.5	26	16	158	JEZ35F.2.130S-FJT
JEZ35F.2.150S	35	150	55	173.2	F.S		F-F	6	24	166	84.5	26	16	178	JEZ35F.2.150S-FJT

单位 (unit): mm

注: F.S 表示全封闭式双侧打开, F-F 表示: 封闭方型接头, 不同序号表示安装孔的不同排列样式

Note: F.S Enclosed open of both side, F-F: enclosed type bracket, Different serial number indicates the difference rank type of fixing holes

固定接头类型及参数 Fix bracket type and parameters (见表格 See table)

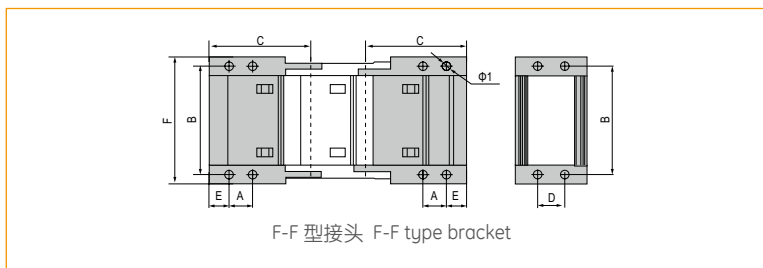

* 可选导向槽配套 Optional: Guide supporting solution

详见 P092
See P092

订货示例 Order Example

示例 拖链内高 35mm、内宽 50mm、半径 100mm、长度 1 米 /15 节 (Sample: inner height 35mm, inner width 50mm, radius 100mm, length 15 links/1 meter)

拖链 Chain JEZ35F.2.50S R100 1000mm /15 Links (实际长度 Physical length: ± 2mm)

接头 Bracket JEZ35F.2.50S-FJT 1 副 (Set)

配件 Accessories 每节装 1 个竖隔片 / 1 个横隔片 (1 vertical shim/1 horizontal shim can be mounted in every link)

JEZ45Q.2.S 系列 - 桥式双侧打开

Series of JEZ45Q.2.S-Bridge type open of both side

JFLO[®]

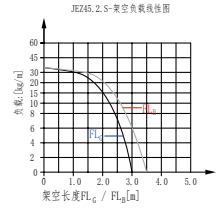
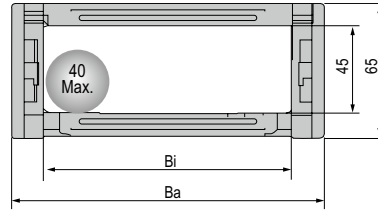

◎ 适用于直径 40 毫米以下线缆 Suitable for 40mm or less of cable.

主要技术参数 Basic technical data

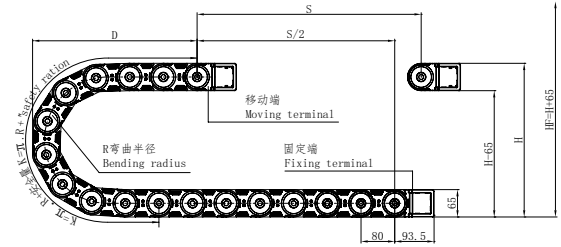

节距 = 80mm, 每米节数 = 13, 链长 = S/2 + K, S = 行程距离, K = π · R + "安全量"
Pitch = 80mm, link per meter = 13, length of chain = S/2 + K, S = stroke. K = π · R + "safety ration"

R	75	100	125	150	200	250	300
H	215	265	315	365	465	565	665
D	188	213	238	263	313	363	413
K	400	480	560	640	800	960	1120

安装实际高度 :H_F = H + 65mm (负载 28kg/m)

Actual mounting height: H_F = H + 65mm (load 28kg/m)

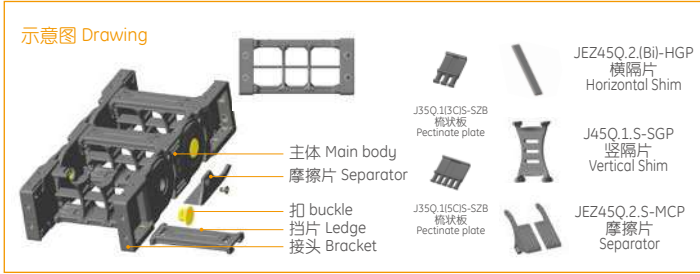

拖链型号 Cable Chain No.	内高 Hi	内宽 Bi	外高 Ha	外宽 Ba	款式 Styles	弯曲半径 Bending radius R	固定接头类型及参数 Bracket type and parameters								
							可配接头类型 Applicable bracket type	孔径 Bore diameter Φ1	孔距 (mm) hole distance						接头代号 Bracket No.
									A	B	C	D	E	F	
JEZ45Q.2.50S	45	50	65	76.2	Q.S	75.100.125. 150.200.250. 300	F-Q	6	23.5	68	93.5	25.5	16	83.5	JEZ45Q.2.50S-FJT
JEZ45Q.2.60S	45	60	65	86.2	Q.S		F-Q	6	23.5	78	93.5	25.5	16	93.5	JEZ45Q.2.60S-FJT
JEZ45Q.2.75S	45	75	65	101.2	Q.S		F-Q	6	23.5	93	93.5	25.5	16	108.5	JEZ45Q.2.75S-FJT
JEZ45Q.2.90S	45	90	65	116.2	Q.S		F-Q	6	23.5	108	93.5	25.5	16	123.5	JEZ45Q.2.90S-FJT
JEZ45Q.2.100S	45	100	65	126.2	Q.S		F-Q	6	23.5	118	93.5	25.5	16	133.5	JEZ45Q.2.100S-FJT
JEZ45Q.2.117S	45	117	65	143.2	Q.S		F-Q	6	23.5	135	93.5	25.5	16	150.5	JEZ45Q.2.117S-FJT
JEZ45Q.2.125S	45	125	65	151.2	Q.S		F-Q	6	23.5	143	93.5	25.5	16	158.5	JEZ45Q.2.125S-FJT
JEZ45Q.2.130S	45	130	65	156.2	Q.S		F-Q	6	23.5	148	93.5	25.5	16	163.5	JEZ45Q.2.130S-FJT
JEZ45Q.2.150S	45	150	65	176.2	Q.S		F-Q	6	23.5	168	93.5	25.5	16	183.5	JEZ45Q.2.150S-FJT
JEZ45Q.2.154S	45	154	65	180.2	Q.S		F-Q	6	23.5	172	93.5	25.5	16	187.5	JEZ45Q.2.154S-FJT
JEZ45Q.2.175S	45	175	65	201.2	Q.S		F-Q	6	23.5	193	93.5	25.5	16	208.5	JEZ45Q.2.175S-FJT
JEZ45Q.2.200S	45	200	65	226.2	Q.S		F-Q	6	23.5	218	93.5	25.5	16	233.5	JEZ45Q.2.200S-FJT
JEZ45Q.2.250S	45	250	65	276.2	Q.S		F-Q	6	23.5	268	93.5	25.5	16	283.5	JEZ45Q.2.250S-FJT
JEZ45Q.2.300S	45	300	65	326.2	Q.S		F-Q	6	23.5	318	93.5	25.5	16	333.5	JEZ45Q.2.300S-FJT

单位 (unit): mm

注: Q.S 表示桥式双侧可打开, F-Q 表示: 桥式方型接头, 不同序号表示安装孔的不同排列样式

Note: Q.S Bridge type open of both side, F-Q: bridge type square bracket, Different serial number indicates the difference rank type of fixing holes

固定接头类型及参数 Fix bracket type and parameters (见表格 See table)

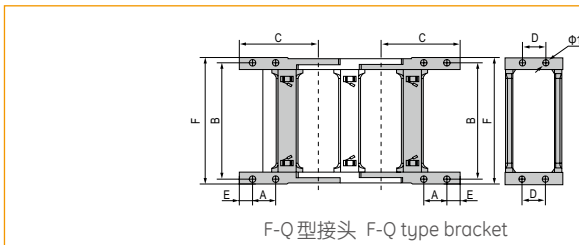

F-Q型接头 F-Q type bracket



* 可选导向槽配套 Optional: Guide supporting solution

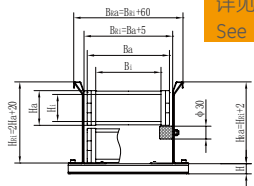

详见 P092
See P092

订货示例 Order Example

示例 拖链内高 45mm、内宽 50mm、半径 75mm、长度 1 米 /13 节 (Sample: inner height 45mm, inner width 50mm, radius 75mm, length 13 links/1 meter)

拖链 Chain JEZ45Q.2.50S R75 1000mm /13 Links (实际长度 Physical length: ± 2mm)

接头 Bracket JEZ45Q.2.50S-FJT 1 副 (Set)

配件 Accessories 每节装 1 个竖隔片 / 1 个横隔片 (1 vertical shim/1 horizontal shim can be mounted in every link)

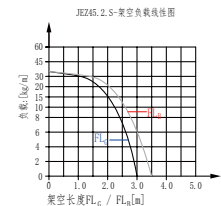
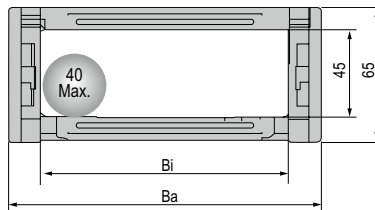

◎ 适用于直径 40 毫米以下线缆 Suitable for 40mm or less of cable.

主要技术参数 Basic technical data

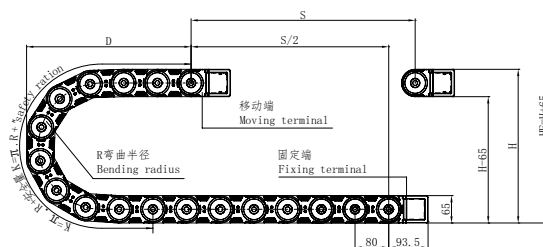

节距 = 80mm, 每米节数 = 13, 链长 = S/2 + K, S = 行程距离, K = π · R + "安全量"
Pitch = 80mm, link per meter = 13, length of chain = S/2 + K, S = stroke, K = π · R + "safety ration"

R	100	125	150	200	250	300
H	265	315	365	465	565	665
D	213	238	263	313	363	413
K	480	560	640	800	960	1120

安装实际高度 :H_f = H + 65mm (负载 28kg/m)

Actual mounting height: H_f = H + 65mm (load 28kg/m)

示意图 Drawing

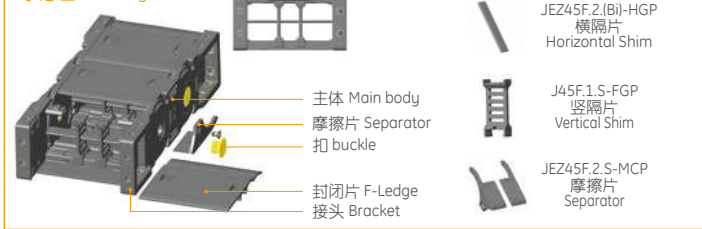

拖链型号 Cable Chain No.	内高 Hi	内宽 Bi	外高 Ha	外宽 Ba	款式 Styles	弯曲半径 Bending radius R	固定接头类型及参数 Bracket type and parameters								
							可配接头类型 Applicable bracket type	孔径 Bore diameter Φ1	孔距 (mm) hole distance					接头代号 Bracket No.	
									A	B	C	D	E		F
JEZ45F.2.50S	45	50	65	76.2	F.S	100.125. 150.200. 250.300	F-F	6	23.5	68	93.5	25.5	16	83.5	JEZ45F.2.50S-FJT
JEZ45F.2.60S	45	60	65	86.2	F.S		F-F	6	23.5	78	93.5	25.5	16	93.5	JEZ45F.2.60S-FJT
JEZ45F.2.75S	45	75	65	101.2	F.S		F-F	6	23.5	93	93.5	25.5	16	108.5	JEZ45F.2.75S-FJT
JEZ45F.2.90S	45	90	65	116.2	F.S		F-F	6	23.5	108	93.5	25.5	16	123.5	JEZ45F.2.90S-FJT
JEZ45F.2.100S	45	100	65	126.2	F.S		F-F	6	23.5	118	93.5	25.5	16	133.5	JEZ45F.2.100S-FJT
JEZ45F.2.125S	45	125	65	151.2	F.S		F-F	6	23.5	143	93.5	25.5	16	158.5	JEZ45F.2.125S-FJT
JEZ45F.2.130S	45	130	65	156.2	F.S		F-F	6	23.5	148	93.5	25.5	16	163.5	JEZ45F.2.130S-FJT
JEZ45F.2.150S	45	150	65	176.2	F.S		F-F	6	23.5	168	93.5	25.5	16	183.5	JEZ45F.2.150S-FJT
JEZ45F.2.175S	45	175	65	201.2	F.S		F-F	6	23.5	193	93.5	25.5	16	208.5	JEZ45F.2.175S-FJT
JEZ45F.2.200S	45	200	65	226.2	F.S		F-F	6	23.5	218	93.5	25.5	16	233.5	JEZ45F.2.200S-FJT

注: F.S 表示全封闭式双侧打开, F-F 表示: 封闭方型接头, 不同序号表示安装孔的不同排列样式

Note: F.S Enclosed open of both side, F-F: enclosed type bracket, Different serial number indicates the difference rank type of fixing holes

单位 (unit): mm

固定接头类型及参数 Fix bracket type and parameters (见表格 See table)

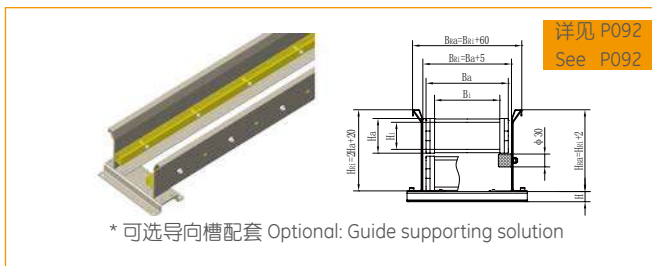
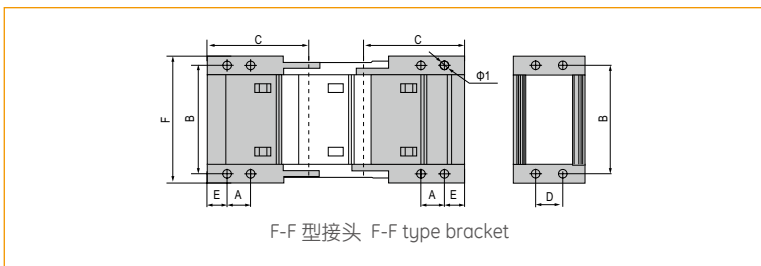

订货示例 Order Example

示例 拖链内高 45mm、内宽 50mm、半径 100mm、长度 1 米 / 13 节 (Sample: inner height 45mm, inner width 50mm, radius 100mm, length 13 links/1 meter)

拖链 Chain JEZ45F.2.50S R100 1000mm / 13 Links (实际长度 Physical length: ± 2mm)

接头 Bracket JEZ45F.2.50S-FJT 1 副 (Set)

配件 Accessories 每节装 1 个竖隔片 / 1 个横隔片 (1 vertical shim/1 horizontal shim can be mounted in every link)

JEZ55Q.2.S 系列 - 桥式双侧打开

Series of JEZ55Q.2.S-Bridge type open of both side

JFLO[®]

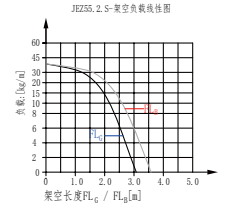
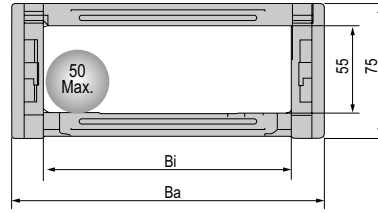

◎ 适用于直径 50 毫米以下线缆 Suitable for 50mm or less of cable.

主要技术参数 Basic technical data

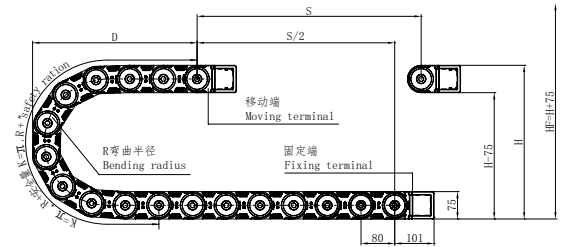

节距=80mm, 每米节数=13, 链长=S/2+K, S=行程距离, K=π·R+“安全量”
Pitch=80mm, link per meter=13, length of chain=S/2+K, S=stroke. K=π·R+“safety ration”

R	75	100	125	150	200	250	300
H	225	275	325	375	475	575	675
D	193	218	243	268	318	368	418
K	400	480	560	640	800	960	1120

安装实际高度:H_F=H+75mm(负载 3kg/m)

Actual mounting height:H_F=H+75mm(load 3kg/m)

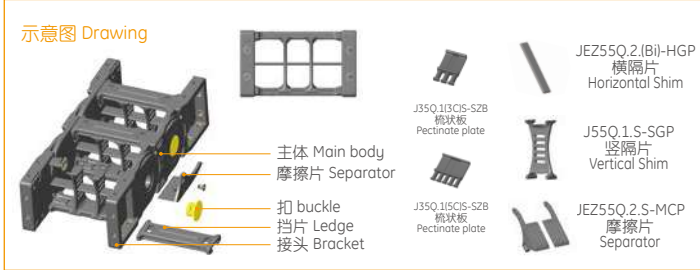

拖链型号 Cable Chain No.	内高 Hi	内宽 Bi	外高 Ha	外宽 Ba	款式 Styles	弯曲半径 Bending radius R	固定接头类型及参数 Bracket type and parameters								
							可配接头类型 Applicable bracket type	孔径 Bore diameter Φ1	孔距 (mm)hole distance						接头代号 Bracket No.
									A	B	C	D	E	F	
JEZ55Q.2.50S	55	50	75	79.6	Q.S	75,100,125, 150,200,250,300	F-Q	6	30	68.5	101	30	17	84	JEZ55Q.2.50S-FJT
JEZ55Q.2.60S	55	60	75	89.6	Q.S		F-Q	6	30	78.5	101	30	17	94	JEZ55Q.2.60S-FJT
JEZ55Q.2.75S	55	75	75	104.6	Q.S		F-Q	6	30	93.5	101	30	17	109	JEZ55Q.2.75S-FJT
JEZ55Q.2.90S	55	90	75	119.6	Q.S		F-Q	6	30	108.5	101	30	17	124	JEZ55Q.2.90S-FJT
JEZ55Q.2.100S	55	100	75	129.6	Q.S		F-Q	6	30	118.5	101	30	17	134	JEZ55Q.2.100S-FJT
JEZ55Q.2.117S	55	117	75	146.6	Q.S		F-Q	6	30	135.5	101	30	17	151	JEZ55Q.2.117S-FJT
JEZ55Q.2.125S	55	125	75	154.6	Q.S		F-Q	6	30	143.5	101	30	17	159	JEZ55Q.2.125S-FJT
JEZ55Q.2.130S	55	130	75	159.6	Q.S		F-Q	6	30	148.5	101	30	17	164	JEZ55Q.2.130S-FJT
JEZ55Q.2.150S	55	150	75	179.6	Q.S		F-Q	6	30	168.5	101	30	17	184	JEZ55Q.2.150S-FJT
JEZ55Q.2.154S	55	154	75	183.6	Q.S		F-Q	6	30	172.5	101	30	17	188	JEZ55Q.2.154S-FJT
JEZ55Q.2.175S	55	175	75	204.6	Q.S		F-Q	6	30	193.5	101	30	17	209	JEZ55Q.2.175S-FJT
JEZ55Q.2.200S	55	200	75	229.6	Q.S		F-Q	6	30	218.5	101	30	17	234	JEZ55Q.2.200S-FJT
JEZ55Q.2.250S	55	250	75	279.6	Q.S		F-Q	6	30	268.5	101	30	17	284	JEZ55Q.2.250S-FJT
JEZ55Q.2.300S	55	300	75	329.6	Q.S		F-Q	6	30	318.5	101	30	17	334	JEZ55Q.2.300S-FJT

单位 (unit): mm

注: Q.S 表示桥式双侧可打开, F-Q 表示: 桥式方型接头, 不同序号表示安装孔的不同排列样式

Note: Q.S Bridge type open of both side, F-Q: bridge type square bracket, Different serial number indicates the difference rank type of fixing holes

固定接头类型及参数 Fix bracket type and parameters (见表格 See table)

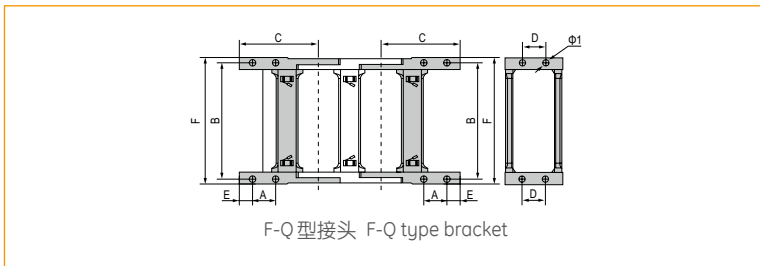

订货示例 Order Example

示例 拖链内高 55mm、内宽 50mm、半径 75mm、长度 1 米 /13 节 (Sample: inner height 55mm, inner width 50mm, radius 75mm, length 13 links/1 meter)

拖链 Chain JEZ55Q.2.50S R75 1000mm /13 Links (实际长度 Physical length: ± 2mm)

接头 Bracket JEZ55Q.2.50S-FJT 1 副 (Set)

配件 Accessories 每节装 1 个竖隔片 / 1 个横隔片 (1 vertical shim/1 horizontal shim can be mounted in every link)

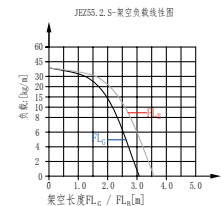
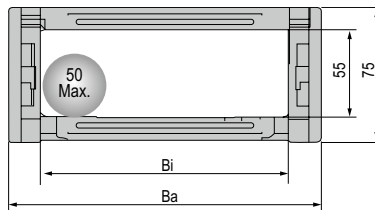

◎ 适用于直径 50 毫米以下线缆 Suitable for 50mm or less of cable.

主要技术参数 Basic technical data

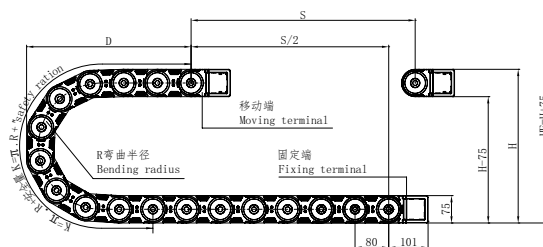

节距=80mm, 每米节数=13, 链长=S/2+K, S=行程距离, K=π·R+“安全量”
Pitch=80mm, link per meter=13, length of chain=S/2+K, S=stroke, K=π·R+“safety ration”

R	125	150	200	225	250	300
H	325	375	475	525	575	675
D	243	268	318	343	368	418
K	560	640	800	880	960	1120

安装实际高度: $H_f = H + 75\text{mm}$ (负载 3kg/m)

Actual mounting height: $H_f = H + 75\text{mm}$ (load 3kg/m)

示意图 Drawing

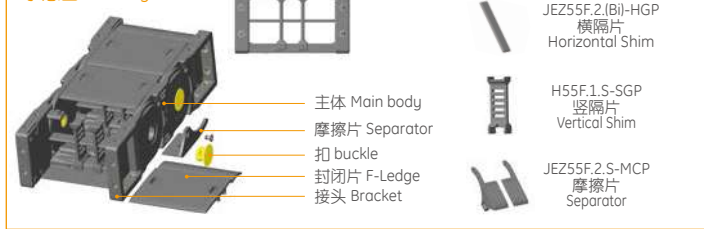

拖链型号 Cable Chain No.	内高 Hi	内宽 Bi	外高 Ha	外宽 Ba	款式 Styles	弯曲半径 Bending radius R	固定接头类型及参数 Bracket type and parameters								
							可配接头类型 Applicable bracket type	孔径 Bore diameter Φ1	孔距 (mm)hole distance						接头代号 Bracket No.
JEZ55F.2.50S	55	50	75	79.6	F.S	125.150. 200.225. 250.300.	F-F	6	30	68.5	101	30	17	84	JEZ55F.2.50S-FJT
JEZ55F.2.60S	55	60	75	89.6	F.S		F-F	6	30	78.5	101	30	17	94	JEZ55F.2.60S-FJT
JEZ55F.2.75S	55	75	75	104.6	F.S		F-F	6	30	93.5	101	30	17	109	JEZ55F.2.75S-FJT
JEZ55F.2.90S	55	90	75	119.6	F.S		F-F	6	30	108.5	101	30	17	124	JEZ55F.2.90S-FJT
JEZ55F.2.100S	55	100	75	129.6	F.S		F-F	6	30	118.5	101	30	17	134	JEZ55F.2.100S-FJT
JEZ55F.2.125S	55	125	75	154.6	F.S		F-F	6	30	143.5	101	30	17	159	JEZ55F.2.125S-FJT
JEZ55F.2.130S	55	130	75	159.6	F.S		F-F	6	30	148.5	101	30	17	164	JEZ55F.2.130S-FJT
JEZ55F.2.150S	55	150	75	179.6	F.S		F-F	6	30	168.5	101	30	17	184	JEZ55F.2.150S-FJT
JEZ55F.2.175S	55	175	75	204.6	F.S		F-F	6	30	193.5	101	30	17	209	JEZ55F.2.175S-FJT
JEZ55F.2.200S	55	200	75	229.6	F.S		F-F	6	30	218.5	101	30	17	234	JEZ55F.2.200S-FJT

注: F.S 表示全封闭式双侧打开, F-F 表示: 封闭方型接头, 不同序号表示安装孔的不同排列样式

Note: F.S Enclosed open of both side, F-F: enclosed type bracket, Different serial number indicates the difference rank type of fixing holes

单位 (unit): mm

固定接头类型及参数 Fix bracket type and parameters (见表格 See table)

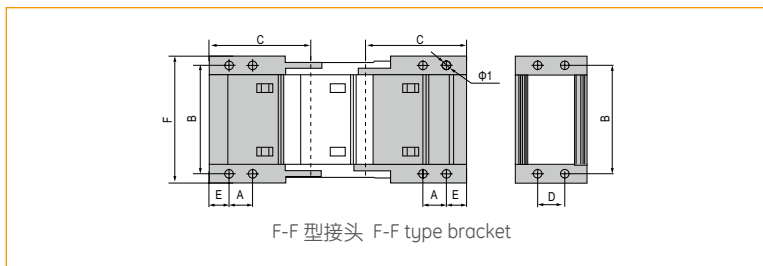

订货示例 Order Example

示例 拖链内高 55mm、内宽 50mm、半径 125mm、长度 1 米 /13 节 (Sample: inner height 55mm, inner width 50mm, radius 125mm, length 22 links/1 meter)

拖链 Chain JEZ55F.2.50S R125 1000mm /13 Links (实际长度 Physical length: ±2mm)

接头 Bracket JEZ55F.2.50S-FJT 1 副 (Set)

配件 Accessories 每节装 1 个竖隔片 / 1 个横隔片 (1 vertical shim/1 horizontal shim can be mounted in every link)

JEZ65Q.2.S 系列 - 桥式双侧打开

Series of JEZ65Q.2.S-Bridge type open of both side

JFLO[®]

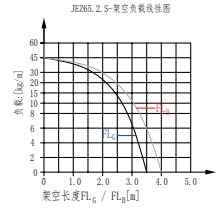
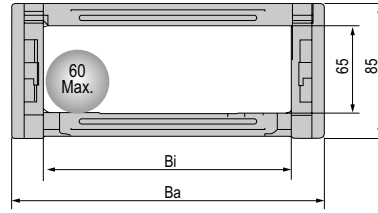

◎ 适用于直径 60 毫米以下线缆 Suitable for 60mm or less of cable.

主要技术参数 Basic technical data

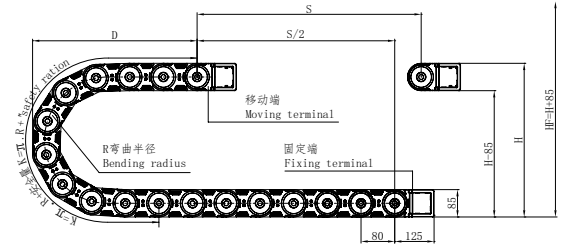

节距 = 80mm, 每米节数 = 13, 链长 = S/2 + K, S = 行程距离, K = π · R + "安全量"
Pitch = 80mm, link per meter = 13, length of chain = S/2 + K, S = stroke. K = π · R + "safety ration"

R	125	150	200	250	300	400	500
H	335	385	485	585	685	885	1085
D	248	273	323	373	423	523	623
K	560	640	800	960	1120	1440	1760

安装实际高度 :H_f = H + 85mm (负载 3kg/m)

Actual mounting height: H_f = H + 85mm (load 3kg/m)

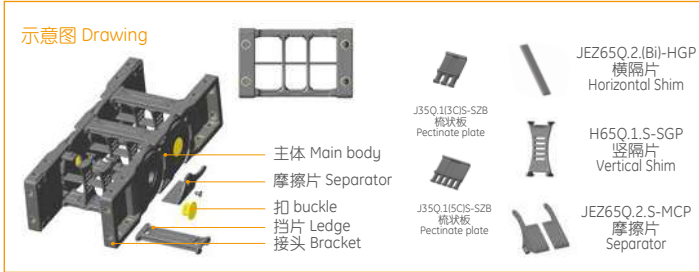

拖链型号 Cable Chain No.	内高 Hi	内宽 Bi	外高 Ha	外宽 Ba	款式 Styles	弯曲半径 Bending radius R	固定接头类型及参数 Bracket type and parameters								
							可配接头类型 Applicable bracket type	孔径 Bore diameter Φ1	孔距 (mm) hole distance					接头代号 Bracket No.	
									A	B	C	D	E		F
JEZ65Q.2.50S	65	50	85	81.6	Q.S	125. 150. 200 500	F-Q	9	35	72	125	45	20	90	JEZ65Q.2.50S-FJT
JEZ65Q.2.60S	65	60	85	91.6	Q.S		F-Q	9	35	82	125	45	20	100	JEZ65Q.2.60S-FJT
JEZ65Q.2.75S	65	75	85	106.6	Q.S		F-Q	9	35	97	125	45	20	115	JEZ65Q.2.75S-FJT
JEZ65Q.2.90S	65	90	85	121.6	Q.S		F-Q	9	35	112	125	45	20	130	JEZ65Q.2.90S-FJT
JEZ65Q.2.100S	65	100	85	131.6	Q.S		F-Q	9	35	122	125	45	20	140	JEZ65Q.2.100S-FJT
JEZ65Q.2.117S	65	117	85	148.6	Q.S		F-Q	9	35	139	125	45	20	157	JEZ65Q.2.117S-FJT
JEZ65Q.2.125S	65	125	85	156.6	Q.S		F-Q	9	35	147	125	45	20	165	JEZ65Q.2.125S-FJT
JEZ65Q.2.130S	65	130	85	161.6	Q.S		F-Q	9	35	152	125	45	20	170	JEZ65Q.2.130S-FJT
JEZ65Q.2.150S	65	150	85	181.6	Q.S		F-Q	9	35	172	125	45	20	190	JEZ65Q.2.150S-FJT
JEZ65Q.2.154S	65	154	85	185.6	Q.S		F-Q	9	35	176	125	45	20	194	JEZ65Q.2.154S-FJT
JEZ65Q.2.175S	65	175	85	206.6	Q.S		F-Q	9	35	197	125	45	20	215	JEZ65Q.2.175S-FJT
JEZ65Q.2.200S	65	200	85	231.6	Q.S		F-Q	9	35	222	125	45	20	240	JEZ65Q.2.200S-FJT
JEZ65Q.2.250S	65	250	85	281.6	Q.S		F-Q	9	35	272	125	45	20	290	JEZ65Q.2.250S-FJT
JEZ65Q.2.300S	65	300	85	331.6	Q.S		F-Q	9	35	322	125	45	20	340	JEZ65Q.2.300S-FJT

单位 (unit): mm

注: Q.S 表示桥式两侧可打开, F-Q 表示: 桥式方型接头, 不同序号表示安装孔的不同排列样式

Note: Q.S Bridge type open of both side, F-Q: bridge type square bracket, Different serial number indicates the difference rank type of fixing holes

固定接头类型及参数 Fix bracket type and parameters (见表格 See table)

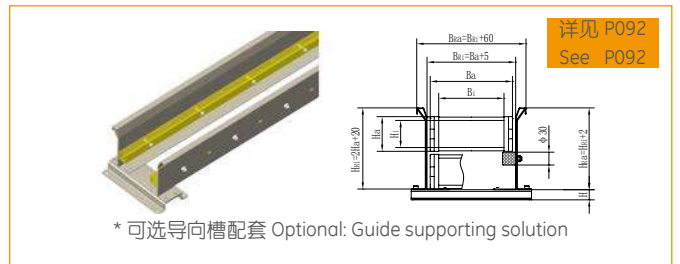
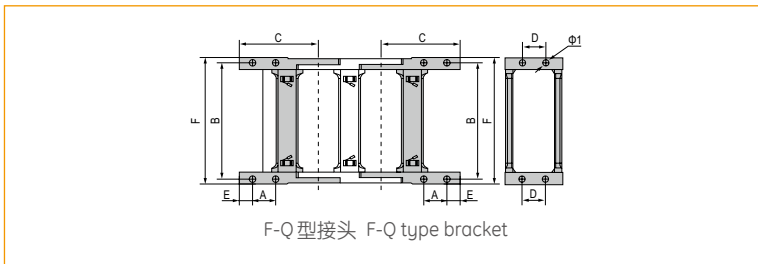

订货示例 Order Example

示例 拖链内高 65mm、内宽 50mm、半径 125mm、长度 1 米 /13 节 (Sample: inner height 65mm, inner width 50mm, radius 125mm, length 13 links/1 meter)

拖链 Chain JEZ65Q.2.50S R125 1000mm/13 Links (实际长度 Physical length: ± 2mm)

接头 Bracket JEZ65Q.2.50S-FJT 1 副 (Set)

配件 Accessories 每节装 1 个竖隔片 / 1 个横隔片 (1 vertical shim/1 horizontal shim can be mounted in every link)

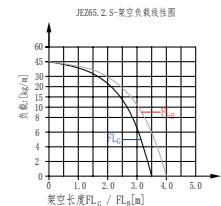
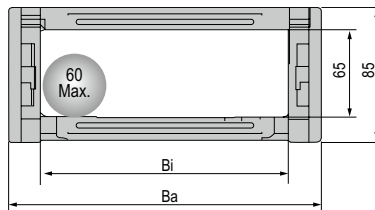

◎ 适用于直径 60 毫米以下线缆 Suitable for 60mm or less of cable.

主要技术参数 Basic technical data

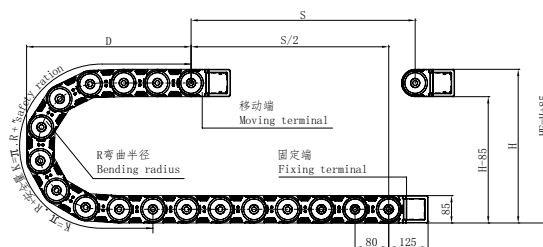

节距 = 80mm, 每米节数 = 13, 链长 = S/2 + K, S = 行程距离, K = π · R + "安全量"
Pitch = 80mm, link per meter = 22, length of chain = S/2 + K, S = stroke. K = π · R + "safety ration"

R	125	150	200	250	300	400	500
H	335	385	485	585	685	885	1085
D	248	273	323	373	423	523	623
K	560	640	800	960	1120	1440	1760

安装实际高度 :H_f = H + 85mm (负载 3kg/m)

Actual mounting height:H_f = H + 85mm (load 3kg/m)

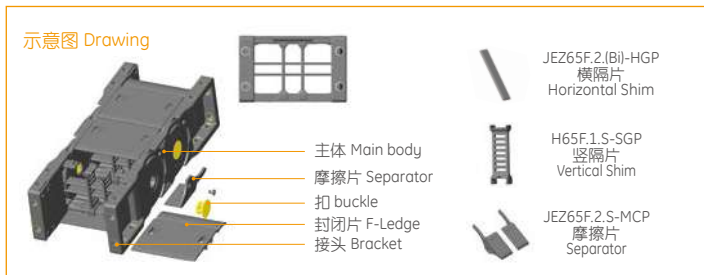

拖链型号 Cable Chain No.	内高 Hi	内宽 Bi	外高 Ha	外宽 Ba	款式 Styles	弯曲半径 Bending radius R	固定接头类型及参数 Bracket type and parameters								
							可配接头类型 Applicable bracket type	孔径 Bore diameter Φ1	孔距 (mm)hole distance					接头代号 Bracket No.	
JEZ65F.2.50S	65	50	85	81.6	F.S	125.150.200 250.300.400 500	F-F	9	35	72	125	45	20	90	JEZ65F.2.50S-FJT
JEZ65F.2.60S	65	60	85	91.6	F.S		F-F	9	35	82	125	45	20	100	JEZ65F.2.60S-FJT
JEZ65F.2.75S	65	75	85	106.6	F.S		F-F	9	35	97	125	45	20	115	JEZ65F.2.75S-FJT
JEZ65F.2.90S	65	90	85	121.6	F.S		F-F	9	35	112	125	45	20	130	JEZ65F.2.90S-FJT
JEZ65F.2.100S	65	100	85	131.6	F.S		F-F	9	35	122	125	45	20	140	JEZ65F.2.100S-FJT
JEZ65F.2.125S	65	125	85	156.6	F.S		F-F	9	35	147	125	45	20	165	JEZ65F.2.125S-FJT
JEZ65F.2.130S	65	130	85	161.6	F.S		F-F	9	35	152	125	45	20	170	JEZ65F.2.130S-FJT
JEZ65F.2.150S	65	150	85	181.6	F.S		F-F	9	35	172	125	45	20	190	JEZ65F.2.150S-FJT
JEZ65F.2.175S	65	175	85	206.6	F.S		F-F	9	35	197	125	45	20	215	JEZ65F.2.175S-FJT
JEZ65F.2.200S	65	200	85	231.6	F.S		F-F	9	35	222	125	45	20	240	JEZ65F.2.200S-FJT

注: F.S 表示全封闭式双侧打开, F-F 表示: 封闭方型接头, 不同序号表示安装孔的不同排列样式

Note: F.S Enclosed open of both side, F-F: enclosed type bracket, Different serial number indicates the difference rank type of fixing holes

单位 (unit): mm

固定接头类型及参数 Fix bracket type and parameters (见表格 See table)

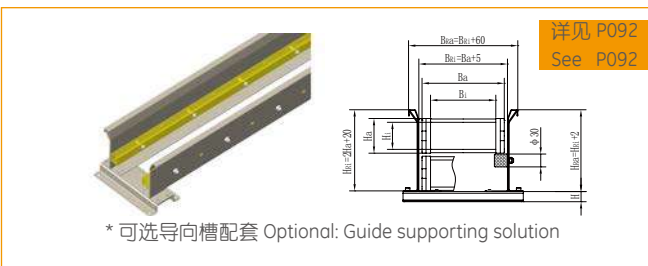
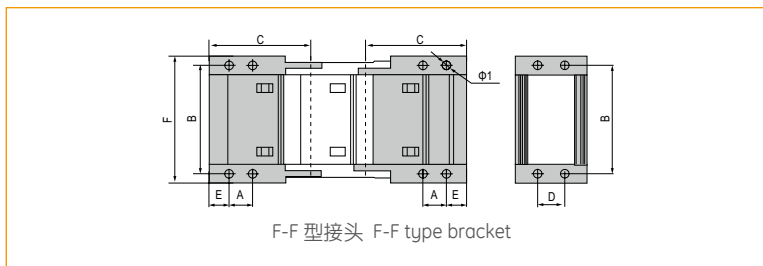

订货示例 Order Example

示例 拖链内高 65mm、内宽 50mm、半径 125mm、长度 1米 /13 节 (Sample: inner height 65mm, inner width 50mm, radius 125mm, length 13 links/1 meter)

拖链 Chain JEZ65F.2.50S R125 1000mm /13 Links (实际长度 Physical length: ± 2mm)

接头 Bracket JEZ65F.2.50S-FJT 1副 (Set)

配件 Accessories 每节装 1 个竖隔片 / 1 个横隔片 (1 vertical shim/1 horizontal shim can be mounted in every link)

JEZ80Q.2.S 系列 - 桥式双侧打开

Series of JEZ80Q.2.S-Bridge type open of both side

JFLO[®]

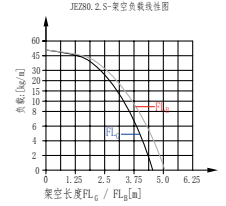
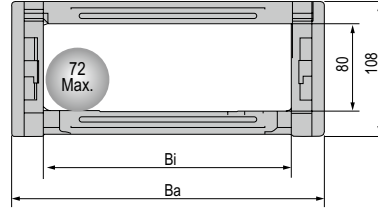

◎ 适用于直径 72 毫米以下线缆 Suitable for 72mm or less of cable.

主要技术参数 Basic technical data

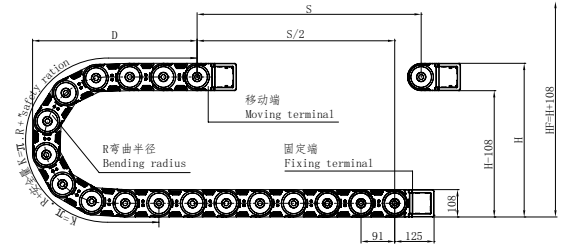

节距=91mm, 每米节数=11, 链长=S/2+K, S=行程距离, K=π·R+“安全量”
Pitch=91mm, link per meter=11, length of chain=S/2+K, S=stroke. K=π·R+“safety ration”

R	150	200	250	300	350	400	500	600
H	408	508	608	708	808	908	1108	1308
D	295	345	395	445	495	545	645	745
K	728	819	1001	1183	1365	1456	1820	2093

安装实际高度 :H_F=H+108mm(负载 3kg/m)

Actual mounting height:H_F=H+108mm(load 3kg/m)

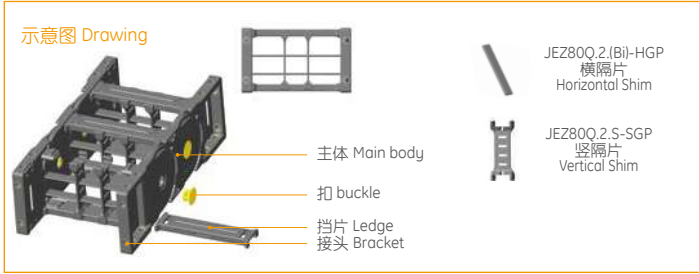

拖链型号 Cable Chain No.	内高 Hi	内宽 Bi	外高 Ha	外宽 Ba	款式 Styles	弯曲半径 Bending radius R	固定接头类型及参数 Bracket type and parameters									
							可配接头类型 Applicable bracket type	孔径 Bore diameter Φ1	孔距 (mm)hole distance						接头代号 Bracket No.	
									A	B	C	D	E	F		
JEZ80Q.2.75S	80	75	108	106	Q.S	150.200.250. 300.350.400. 500.600	F-Q	9	35	95	125	66	20	112	JEZ80Q.2.75S-FJT	
JEZ80Q.2.85S	80	85	108	116	Q.S		F-Q	9	35	105	125	66	20	122	JEZ80Q.2.85S-FJT	
JEZ80Q.2.100S	80	100	108	131	Q.S		F-Q	9	35	120	125	66	20	137	JEZ80Q.2.100S-FJT	
JEZ80Q.2.125S	80	125	108	156	Q.S		F-Q	9	35	145	125	66	20	162	JEZ80Q.2.125S-FJT	
JEZ80Q.2.150S	80	150	108	181	Q.S		F-Q	9	35	170	125	66	20	187	JEZ80Q.2.150S-FJT	
JEZ80Q.2.175S	80	175	108	206	Q.S		F-Q	9	35	195	125	66	20	212	JEZ80Q.2.175S-FJT	
JEZ80Q.2.200S	80	200	108	231	Q.S		F-Q	9	35	220	125	66	20	237	JEZ80Q.2.200S-FJT	
JEZ80Q.2.250S	80	250	108	281	Q.S		F-Q	9	35	270	125	66	20	287	JEZ80Q.2.250S-FJT	
JEZ80Q.2.300S	80	300	108	331	Q.S		F-Q	9	35	320	125	66	20	337	JEZ80Q.2.300S-FJT	
JEZ80Q.2.350S	80	350	108	381	Q.S		F-Q	9	35	370	125	66	20	387	JEZ80Q.2.350S-FJT	
JEZ80Q.2.400S	80	400	108	431	Q.S		F-Q	9	35	420	125	66	20	437	JEZ80Q.2.400S-FJT	

注: Q.S 表示桥式两侧可打开, F-Q 表示: 桥式方型接头, 不同序号表示安装孔的不同排列样式

Note: Q.S Bridge type open of both side, F-Q: bridge type square bracket, Different serial number indicates the difference rank type of fixing holes

单位 (unit): mm

固定接头类型及参数 Fix bracket type and parameters (见表格 See table)

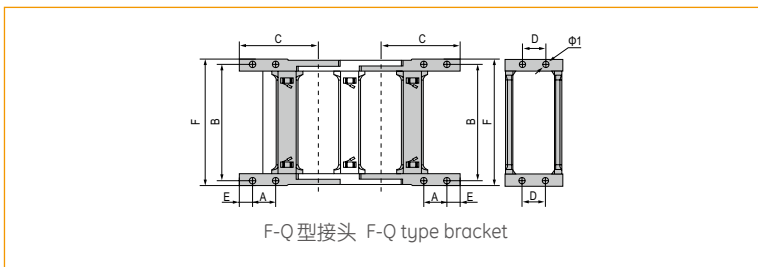

订货示例 Order Example

示例 拖链内高 80mm、内宽 75mm、半径 150mm、长度 1 米 /11 节 (Sample: inner height 80mm, inner width 75mm, radius 150mm, length 11 links/1 meter)

拖链 Chain JEZ80Q.2.75S R150 1000mm /11 Links (实际长度 Physical length: ± 2mm)

接头 Bracket JEZ80Q.2.75S-FJT 1 副 (Set)

配件 Accessories 每节装 1 个竖隔片 / 1 个横隔片 (1 vertical shim/1 horizontal shim can be mounted in every link)

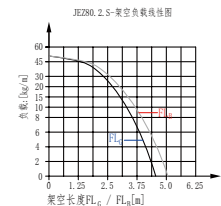
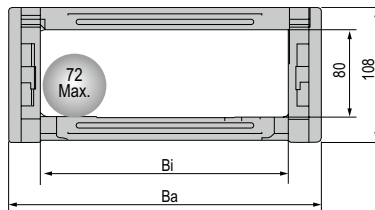

◎ 适用于直径 72 毫米以下线缆 Suitable for 72mm or less of cable.

主要技术参数 Basic technical data

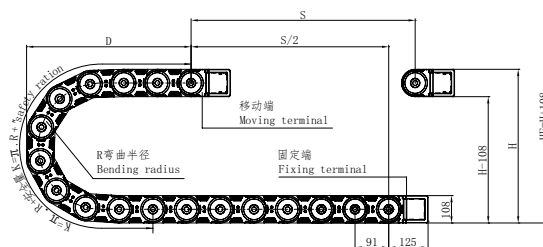

节距=91mm, 每米节数=11, 链长=S/2+K, S=行程距离, K=π·R+“安全量”
Pitch=91mm, link per meter=11, length of chain=S/2+K, S=stroke. K=π·R+“safety ration”

R	150	200	250	300	350	400	500	600
H	408	508	608	708	808	908	1108	1308
D	295	345	395	445	495	545	645	745
K	728	819	1001	1183	1365	1456	1820	2093

安装实际高度 :H_f=H+108mm(负载 3kg/m)

Actual mounting height:H_f=H+108mm(load 3kg/m)

示意图 Drawing

拖链型号 Cable Chain No.	内高 Hi	内宽 Bi	外高 Ha	外宽 Ba	款式 Styles	弯曲半径 Bending radius R	固定接头类型及参数 Bracket type and parameters								
							可配接头类型 Applicable bracket type	孔径 Bore diameter φ1	孔距 (mm)hole distance					接头代号 Bracket No.	
									A	B	C	D	E		F
JEZ80F.2.100S	80	100	108	131	F.S	150.200.250 300.350.400 500.600	F-F	9	35	120	125	66	20	137	JEZ80F.2.100S-FJT
JEZ80F.2.125S	80	125	108	156	F.S		F-F	9	35	145	125	66	20	172	JEZ80F.2.125S-FJT
JEZ80F.2.150S	80	150	108	181	F.S		F-F	9	35	170	125	66	20	187	JEZ80F.2.150S-FJT
JEZ80F.2.200S	80	200	108	231	F.S		F-F	9	35	220	125	66	20	237	JEZ80F.2.200S-FJT
JEZ80F.2.250S	80	250	108	281	F.S		F-F	9	35	270	125	66	20	287	JEZ80F.2.250S-FJT
JEZ80F.2.300S	80	300	108	331	F.S		F-F	9	35	320	125	66	20	337	JEZ80F.2.300S-FJT
JEZ80F.2.350S	80	350	108	381	F.S		F-F	9	35	370	125	66	20	387	JEZ80F.2.350S-FJT

单位 (unit): mm

注: F.S 表示全封闭式双侧打开, F-F 表示: 封闭型接头, 不同序号表示安装孔的不同排列样式

Note: F.S Enclosed open of both side, F-F: enclosed type bracket, Different serial number indicates the difference rank type of fixing holes

固定接头类型及参数 Fix bracket type and parameters (见表格 See table)

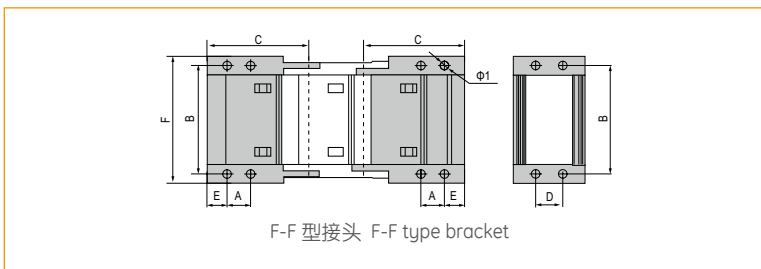

* 可选导向槽配套 Optional: Guide supporting solution

详见 P092
See P092

订货示例 Order Example

示例 拖链内高 80mm、内宽 150mm、半径 150mm、长度 1 米 /11 节 (Sample: inner height 80mm, inner width 150mm, radius 150mm, length 11 links/1 meter)

拖链 Chain JEZ80F.2.150S R150 1000mm /11 Links (实际长度 Physical length: ±2mm)

接头 Bracket JEZ80F.2.150S-FJT 1 副 (Set)

配件 Accessories 每节装 1 个竖隔片 / 1 个横隔片 (1 vertical shim/1 horizontal shim can be mounted in every link)

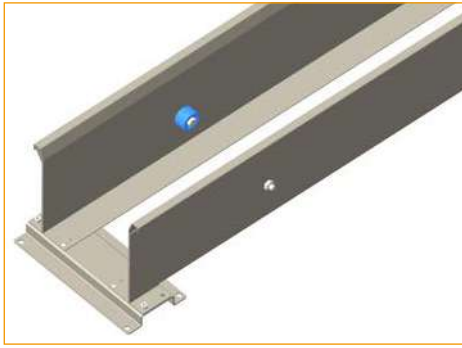

导向槽配套滚轮应用方案

Guide groove supporting roller application solution

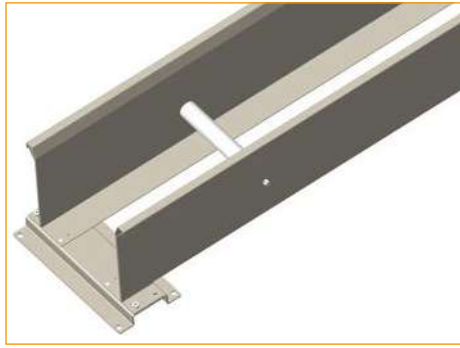

导向槽配套无动力滚轮应用方案

Guide groove supporting non-powered roller application solution



导向槽配套应用方案

Guide groove supporting application solution

1、拖链在导向槽内滑行应用示意图，拖链固定端位于行程的中间位置。

1. Schematic diagram of the application of the cable chain sliding in the guide groove, the fixed end of the cable chain is located in the middle of the stroke.

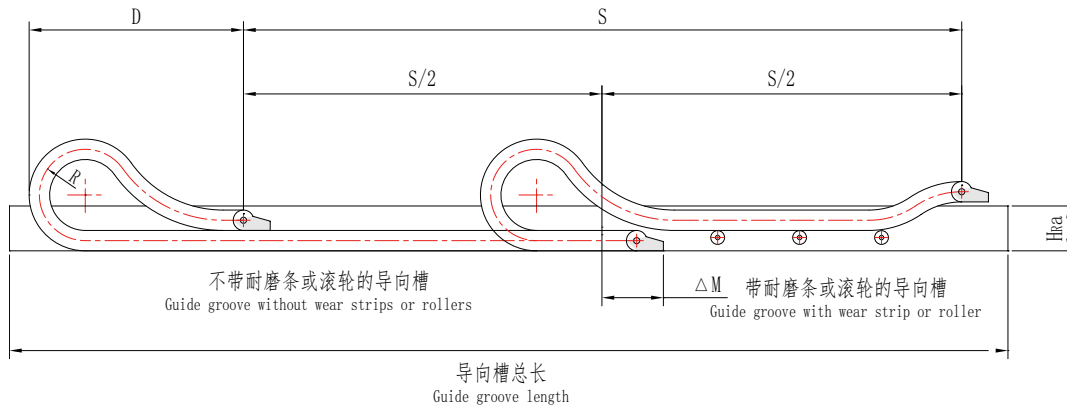

2、导向槽配套滚轮技术参数

2. Technical parameters of guide groove matching rollers

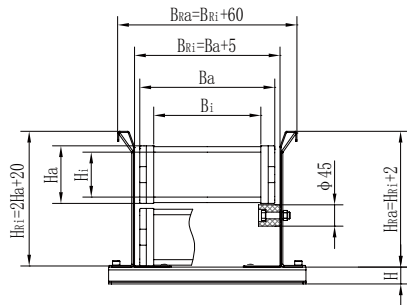

3、导向槽配套无动力滚轮技术参数

3. Technical parameters of non-powered rollers supporting guide grooves

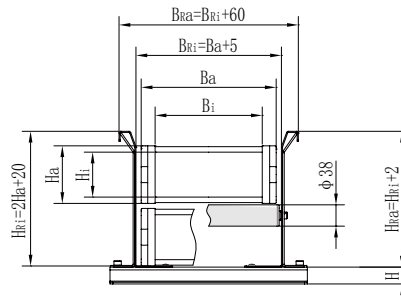

4、导向槽配套耐磨条技术参数

4. Technical parameters of wear-resistant strips for guide grooves

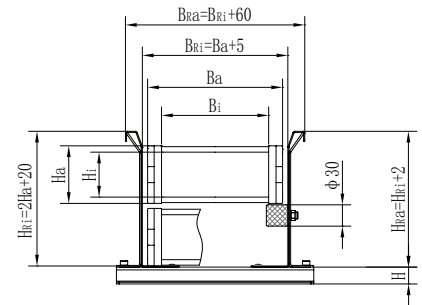

5、导向槽标识说明 Guide groove identification description

Bi= 拖链内宽
Ba= 拖链外宽
Bri= 导向槽内宽
B Ra= 导向槽外宽
Hi= 拖链内高

Bi = inner width of cable chain
Ba=Outer width of cable chain
Bri = inner width of guide groove
B Ra=Outer width of guide groove
Hi=High inside cable chain

Ha= 拖链外高
H Ri= 导向槽内高
H Ra= 导向槽外高
H = 导向槽固定架高度

Ha=Outer height of cable chain
H Ri=High inside guide groove
H Ra=Outer height of guide groove
H=Height of guide trough holder

6、导向槽下单说明 Guide slot order instructions

6.1、导向槽侧板长度及数量根据使用条件确定；
6.2、导向槽配套滚轮结构样式根据拖链安装使用条件确定；
6.3、导向槽安装外形尺寸根据相应规格拖链确定。

6.1. The length and quantity of the side plates of the guide groove are determined according to the conditions of use;
6.2. The structural style of the roller supporting the guide groove is determined according to the installation and use conditions of the cable chain;
6.3. The installation dimensions of the guide groove are determined according to the corresponding specifications of the cable chain.